

MICRA

Interface Description



Copyright by Carl Valentin GmbH / 7918015.0409

Information on the scope of delivery, appearance, performance, dimensions and weight reflect our knowledge at the time of printing.

We reserve the rights to make modifications.

All rights, including those regarding the translation, are reserved.

No part of this document may be reproduced in any form (print, photocopy or any other method) or edited, copied or distributed electronically without written permission from Carl Valentin GmbH.

Due to the constant further development of our devices discrepancies between manual and device can occur.

Please check www.carl-valentin.de for the latest update.

Trademarks

All named brands or trademarks are registered brands or registered trademarks of their respective owners and may not be separately labelled. It must not be concluded from the missing labelling that it is not a registered brand or a registered trademark.



Carl Valentin GmbH

Postfach 3744
78026 Villingen-Schwenningen
Neckarstraße 78 – 86 u. 94
78056 Villingen-Schwenningen

Phone +49 (0)7720 9712-0
Fax +49 (0)7720 9712-9901

E-Mail info@carl-valentin.de
Internet www.carl-valentin.de

SERIAL DATA TRANSMISSION.....	1
XON / XOFF - Protocol.....	1
Connector assignment (9-pin DSUB socket).....	1
Connecion RS 232.....	2
Connector assignment RS485 and RS422.....	3
PARALLEL DATA TRANSMISSION	4
Connection	5
ROTATION OF TEXT, CODE AND GRAPHIC	6
DATUMPOINT.....	6
DATA FORMAT.....	7
Explanations.....	8
Definition of field attributes/field properties (optional).....	9
Field names.....	10
Field selection by free definable field number.....	11
Foreground and background	12
MASK SET	13
Text	13
Standard code	14
2D bar codes	16
Rectangle	22
Line.....	22
Internal graphic.....	23
TEXT SET	24
Examples.....	25
GRAPHIC	26
General graphic format.....	26
Graphic in PCX format.....	27
VARIABLES	29
Set structure	29
Link field	29
Counter.....	30
Extended counter	31
Currency variable	32
GS1-128 (EAN 128) Parser	32
EPC calculation (Electronic Product Code)	33

PARAMETER SETS.....	34
Label parameter	34
Label photocell	38
Dispensing photocell	39
Printer settings.....	40
Interface	42
Offset values.....	44
Service functions	46
Printing	47
Remote console.....	51
PARAMETER SETS FOR OPTIONS.....	52
Network	52
Cutter.....	55
Dispenser	56
Date and time	57
AUTOSTATUS	61
CHARACTER SETS.....	63
International ANSI character font.....	65
Codepage 437	66
Codepage 850.....	67
Codepage 852.....	68
Codepage 857.....	69
GEM German	70
GEM English.....	71
GEM French	72
GEM Swedish.....	73
GEM Danish	74
FONT EXAMPLES	75
Bitmap fonts (not proportional)	75
Bitmap fonts (proportional)	75
INDEX	77

SERIAL DATA TRANSMISSION

XON / XOFF - Protocol

The XON / XOFF protocol is used in "memory"-mode. The XON-code (HEX 11) indicates that the printer is ready to receive data. When XOFF-code (HEX 13) is shown the transmission of data has to be interrupted. To avoid possible data loss some information will be stored into the data-memory. When receiving, that the memory is empty the XON-code (HEX 11) will be shown again.

Connector assignment (9-pin DSUB socket)

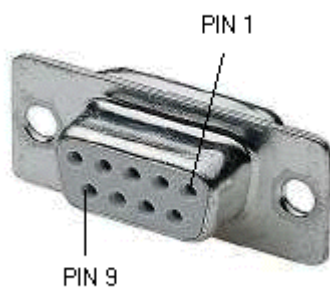

Pin	Signal	Beschreibung
2	R x D	Receiving data line
3	T x D	Transmitting data line
4	DTR	HW Handshake
5	GND	GND Signal

Conexión RS 232

Terminal assignment (cable)

XON / XOFF - report: e.g. connection to an IBM-compatible computer

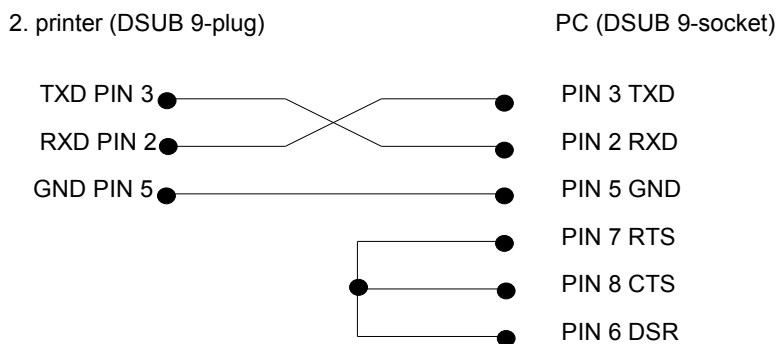
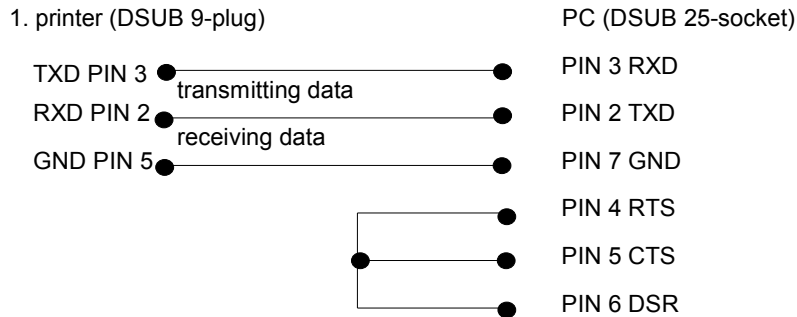

Hardware handshake:

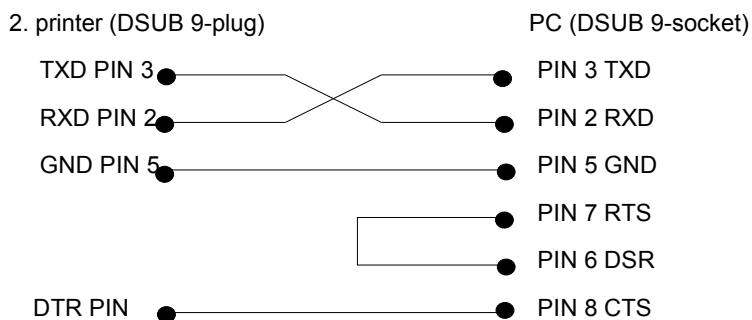
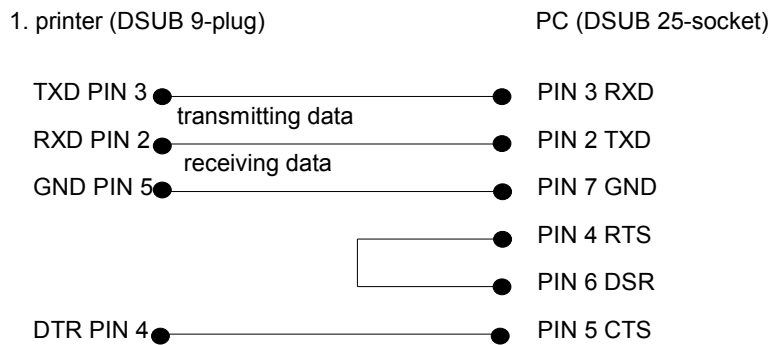

Connector assignment RS485 and RS422

9-pin DSUB socket)

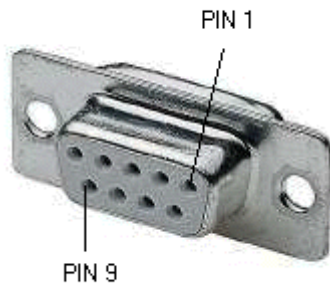

PIN at DSUB socket	Function RS422 (full duplex)	Function RS485 (semi duplex)
1	GND	GND
2	n/c	n/c
3	n/c	n/c
4	RxD-	n/c
5	RxD+	n/c
6	n/c	TxD (RxD)-
7	n/c	TxD (RxD)+
8	TxD-	n/c
9	TxD+	n/c

PARALLEL DATA TRANSMISSION

Interface:	parallel Interface
	synchronising with STROBE - signal
	handshake with BUSY - signal
	all signals are TTL - compatible
Connection:	AMPHENOL - plug 57-30360
PIN 1	In regular condition, this signal is in "HIGH" position. With decreasing amplitude the data acceptance is completed from DATA 1 DATA 8.
PIN 2 . . . 9	DATA 1 DATA 8 parallel data information
PIN 10	<u>ACKNLG</u>
PIN 11	In regular condition this signal is "LOW". With decreasing amplitude of STROBE- signals, BUSY will change onto "HIGH" - level. This level will stay as long as the printer is busy with the already received data byte.

Connection

AMP 36 (Centronic's socket)

Signal Pin-No.	Signal name	Direction	Function
1	$\overline{\text{STROBE}}$	(input)	The $\overline{\text{STROBE}}$ signal indicates that data can be received. The impulse width to the receiving line has to be 0,5 μs at least.
2	DATA 0	(input)	The signals are data bits sent to the printer. A HIGH level corresponds to logical 1 and a LOW level to logical 0.
3	DATA 1	(input)	
4	DATA 2	(input)	
5	DATA 3	(input)	
6	DATA 4	(input)	
7	DATA 5	(input)	
8	DATA 6	(input)	
9	DATA 7	(input)	
10	$\overline{\text{ACKNLG}}$	(output)	An impulse of approx. 12 μs confirms data input for a LOW level and signals the further listening watch of the printer.
11	BUSY	(output)	A HIGH level indicates that the printer cannot receive any data. On the following conditions the signal HIGH is possible: <ol style="list-style-type: none"> 1) for data input (impulse for each sign) 2) during a printing process 3) in Offline status 4) for printer failures
12	PE	(output)	A HIGH level indicates that paper is used up.
13	SELECT	(output)	High Online
14	AUTOFEED		
15	GND		
16	GND		Signal ground.
17	CHASSISGND		Mass, not connected with signal ground.
18	+ 5V		Approx. 4,8 V (max. 100mA)
19-30	GND		Return conductor for twisted pair conductors.
31	not used		-
32	$\overline{\text{FAULT}}$	(output)	Signal goes to LOW, in case <ol style="list-style-type: none"> 1) the paper is used up 2) the printer is Offline or <ol style="list-style-type: none"> 3) an error occurs.
33	not used		
34	not used		
35	not used		
36	not used		

ROTATION OF TEXT, CODE AND GRAPHIC

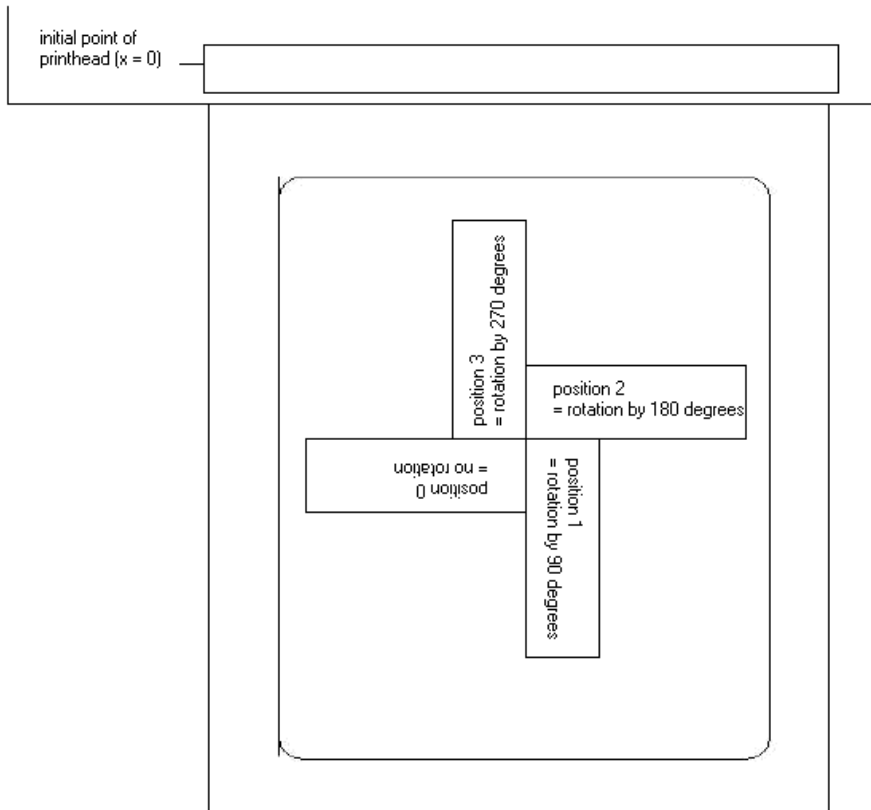

DATUMPOINT

The so-called datum point is the relation point for indication of position. In the meantime the datum point is also the point at which the selected object is rotated.

To determine the datum point in the mask sets, the possible datum points are numbered from left top (1) to right bottom (9). The default datum point is left bottom (7). This datum point is also used even if no indication is found in the mask set.

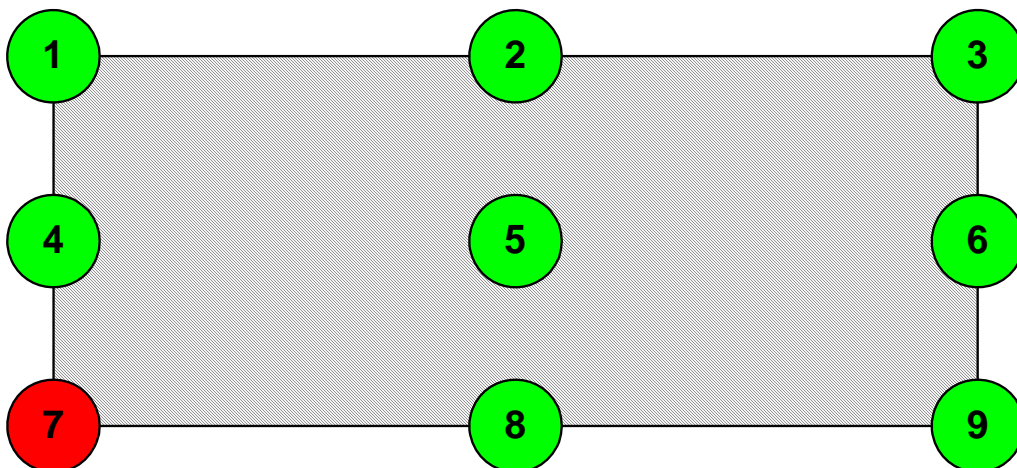

DATA FORMAT

The format of data consists of 4 parts, the mask part, the text, the code (if necessary) and the command part.

For a n-line label the following has to be transmitted:

n	mask sets
n	text sets
n	graphic sets (if necessary)
1	command set

The command set always has to be transmitted at the end!

To each text on a label belongs one MASK SET and one TEXT SET with the same field number.

To each code on a label belongs one MASK SET, one TEXT SET and one CODE SET with the same field number.

To each box or line on a label belongs only one MASK SET.

To each graphic on a label belong several GRAPHIC SETS according to its size res. height, e.g. a graphic with a height of 10 mm needs 80 graphic sets.

Examples:

label with 3 lines text:	3 mask sets 3 text sets 1 command set
label with 3 lines text and 1 code:	4 mask sets 4 text sets 1 code set 1 command set
label with 2 lines text, 1 box and 3 lines:	6 mask sets 2 text sets 1 command set

For all data sets the following is valid:

Each set starts with: **SOH = start of header** → HEX format 01

and ends with: **ETB = end of data transmission block** → HEX format 17

Alternatively it is possible to set SOH to 5E_{Hex} and ETB to 5F_{Hex}. This is necessary if the connected system (e.g. UNIX) cannot transfer control signs.

All other data sets → ASCII format, but they will be transmitted as hexadecimal characters.

Example: A = identification of mask set - transmission: 41_{HEX}
n = field number '01' - transmission: 30_{HEX}, 31_{HEX}

Explanations

x coordinate: distance from right label rim in mm
is measured from the right label rim up to the lower left point of the corresponding line

y coordinate: distance from upper label rim in mm
is measured from the beginning of the label down to the lower left point of the corresponding line

Bitmap fonts not proportional:	Bitmap fonts - not proportional	
	01 = FONT 01	0,8 x 1,1 mm - 127 characters
	02 = FONT 02	1,2 x 1,7 mm - 255 characters
	03 = FONT 03	1,8 x 2,6 mm - 255 characters
	04 = FONT 04	4,0 x 5,6 mm - 127 characters
	05 = FONT 05	1,8 x 3,2 mm - descender - 255 characters
	06 = FONT 06	1,5 x 2,9 mm - 127 characters
	07 = FONT 07	1,2 x 2,2 mm - Unterlängen - 255 characters

Bitmap fonts proportional:	Bitmap fonts - proportional	
	21 = FONT 21	(1,0; 13) - 255 characters
	22 = FONT 22	(1,8; 21) - 255 characters
	23 = FONT 23	(2,6; 31) - 255 characters
	24 = FONT 24	(5,6; 67) - 255 characters
	28 = FONT 28	(4,0; 48) - 255 characters
	29 = FONT 29	(0,8; 9) - 255 characters

In order to reach best print results it is recommended always to chose the biggest possible font.

Definition of field attributes/field properties (optional)

Explanation: Additionally to mask set 'AM[] ...' the possibility was created to define further field properties. In order to achieve a high flexibility, the field properties received own names/identifications. Therefore the sequence as well as the number of field properties are free. If necessary, the mask set 'AC[]' is transferred additionally to mask set 'AM[]' to the printer.

Structure mask set: (SOH)AC[]at1=*value*;at2= *value*;...(ETB)

Attribute (at):	Description
BT BW QZ	ITF 14 (see chapter 'Mask set ITF code') Bearer bar type Bearer bar width Quiet zone in 1/100 mm
NAME	Field name (see page 10) Definition of field name
FN	Field number (see page 11) Free definable field number
BGND FGND	Foreground and background (see page 12) Background of field Foreground of field

This table is constantly extended. The current version is available on demand.

Field names

Application (customized)

1. The label is created with Labelstar Office/Labelstar PLUS.
2. Label data are saved on memory card of printer.
3. An external control (SPS, balance, ERP system, etc.) modifies variable fields of the label (e.g. weight, article no., batch no., etc.) and starts the print of label.

Explanation (Labelstar PLUS only)

So far the fields were designated by numbers (1, 2, 3, ...) which were determined by the order of creation in Labelstar PLUS. By later modifications of label, these field numbers were possibly changed whereby the access to a certain field was no longer possible. By the field names this dependence is annulled.

Procedure - Labelstar PLUS

- a) - Entry of 'Field identifier'.

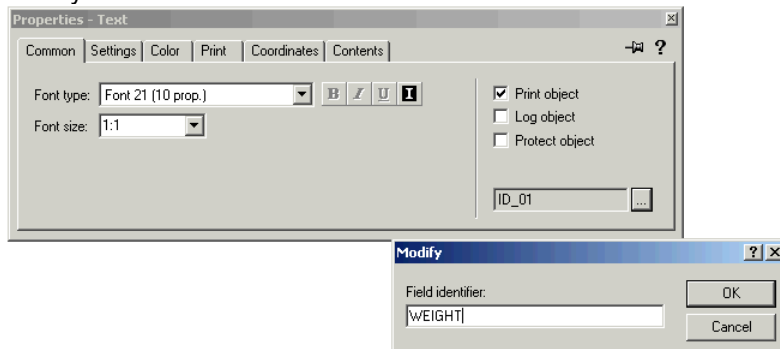

- Selection of option 'Transmit field identifier'.

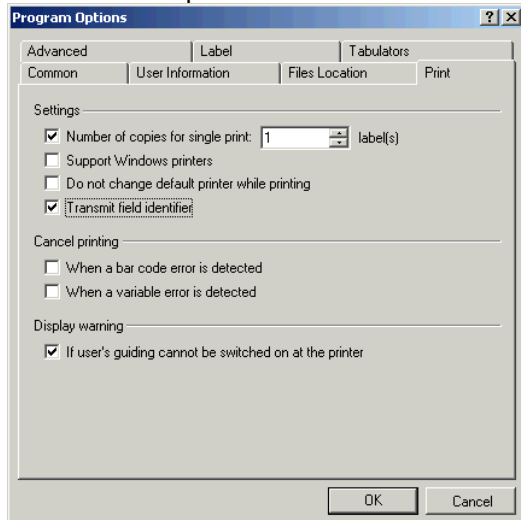

- b) Save label on memory card of printer.
- c) The external control loads first the saved label from memory card of printer with **(SOH)FMB---rF(ETB)**
See chapter 'Memory card'.
- d) With text set **(SOH)BV[NAME]...(ETB)** the contents of field is determined.
- e) With parameter set **(SOH)FBC---rS------(ETB)** the print is started.
See chapter 'printing'.

Procedure - Labelstar Office

- a) The names of field identifiers are assigned and transferred automatically from Labelstar Office to the printer.
- b) Save label on memory card of printer.
- c) The external control loads first the saved label from memory card of printer with **(SOH)FMB---rF(ETB)**
See chapter 'Memory card'.
- d) With text set **(SOH)BV[NAME]...(ETB)** the contents of field is determined.
- e) With parameter set **(SOH)FBC---rS----- (ETB)** the print is started.
See chapter 'printing'.

Field selection by free definable field number

With the following described attribute it is possible to assign a free definable field number to a field. This field number does not have to be clear, i.e. several fields can have the same field number. In this way the same field contents can be assigned to different fields.

The following attribute identification is defined:

Attribute	Description
FN	free definable field number

After the field number was assigned with AC mask statement,

```
(SOH)AC[n]FN=nr(ETB)
```

n = field index

nr = free definable field number

it is possible to access to the field and/or the fields with the new BF text statement:

```
(SOH)BF[nr]text(ETB)
```

nr = field number

text = field contents

Example

```
// Assignment of field number for field 1 and field 2
```

```
(SOH)AM[1]1000;2500;0;4;2;7;400;400;0(ETB)
```

```
(SOH)AC[1]FN=100(ETB)
```

```
(SOH)AM[2]2000;2500;0;30;2;4000;9;3;0;1(ETB)
```

```
(SOH)AC[2]FN=100(ETB)
```

```
// Access to field 1 and field 2 by field number
```

```
(SOH)BF[100]1234567890(ETB)
```

Foreground and background

For following objects/fields the foreground and background can be specified explicitly:

- Bitmap text (only foreground)
- TrueDoc text (only foreground)
- Graphic from memory card (only foreground)
- Line (only foreground)
- Rectangle (only foreground)
- QR Code (only foreground)
- GS1 DataBar (RSS) (only foreground)
- CODABLOCK (only foreground)
- DataMatrix (only foreground)
- PDF417 (only foreground)
- CODABAR (only foreground)
- Code 128 (only foreground)
- Code 2/5 interleaved (only foreground)
- Post Leitcode (only foreground)
- Post Identcode (only foreground)
- ITF 14 (only foreground)
- Code 39 (only foreground)
- Code 39 extended (only foreground)
- Code 93 (only foreground)
- EAN ADD ON (only foreground)
- EAN 13 (only foreground)
- EAN 8 (only foreground)
- GS1-128 (only foreground)
- Pharmacode (only foreground)
- PZN Code (only foreground)
- UPC A (only foreground)
- UPC E (only foreground)

The following attribute identification is defined:

BGND	Background of field
FGND	Foreground of field

The following values can be assigned to the attributes:

0	black
1	white
2	inverted
3	transparent
4	standard

- black: The field contents is generated in black onto the label (previous standard).
white: The field contents is generated in white onto the label.
inverted: The field contents is generated inverted to the background onto the label.
transparent: The field contents is generated transparent onto the label – no change of contents that is generated till then.

If the attribute for the background is set, this effects on all fields within this range, generated so far. With the selection of white or black the fields beneath are covered. If inverted is selected then they change their color.

The attribute value for the foreground always refers to the current background. If no attribute is explicitly set, all generated fields so far in this sector are regarded as background.

At the generation, alwayst the first attribute for the background (if set) and then the attribute for the foreground (if set) is processed.

Example:

```
// Creation of field for bitmap text
(SOH)AM[1]2000;5000;0;1;0;21;2;2;50;7(ETB)

// Text field contents
(SOH)BM[2]Inverted text(ETB)

// Invert text field
(SOH)AC[2]BGND=3;FGND=2(ETB)
```

MASK SET

Text

AM[n]y;x;p;a;d;z;dy;dx;lp;dp	
A	identification for mask set
M	identification for protocol version
n	field number
y	Y coordinate in 1/100 mm
x	X coordinate in 1/100 mm
p	identification for phantom field 0 = print 1 = no print
a	identification for field type 1 = bitmap font 2 = bitmap font invers
d	rotation 0 = 0° 1 = 90° 2 = 180° 3 = 270°
z	character font for not proportional Bitmap fonts (1+2) 01 = FONT 01 0,8 x 1,1 mm 127 characters 02 = FONT 02 1,2 x 1,7 mm 255 characters 03 = FONT 03 1,8 x 2,6 mm 255 characters 04 = FONT 04 4,0 x 5,6 mm 127 characters 05 = FONT 05 1,8 x 3,2 mm - descender 255 characters 06 = FONT 06 1,5 x 2,9 mm 127 characters 07 = FONT 07 1,2 x 2,2 mm - descender 255 characters
	character font for proportional Bitmap fonts (1+2) 21 = FONT 21 (1,0; 13) 255 characters 22 = FONT 22 (1,8; 21) 255 characters 23 = FONT 23 (2,6; 31) 255 characters 24 = FONT 24 (5,6; 67) 255 characters 28 = FONT 28 (4,0; 48) 255 characters 29 = FONT 29 (0,8; 9) 255 characters
dy	extension in direction Y Bitmap fonts factor 0...9
dx	extension in direction X Bitmap fonts factor 0-9
lp	distance between single characters in 1/100 mm
dp	datumpoint 1 = left top 2 = centre top 3 = right top 4 = left centre 5 = centre centre 6 = right centre 7 = left bottom (default) 8 = centre bottom 9 = right bottom

Standard code

AM[n;y;x;p;a;d;h;v1;v2;pz;z;dp	
A	identification for mask set
M	identification for protocol version
n	field number
y	Y position in 1/100 mm
x	X position in 1/100 mm
p	identification for phantom field 0 = print 1 = no print
a	identification for field type 30 = Code 39 31 = Code 2/5 interleaved 32 = EAN 8 33 = EAN 13 34 = UPC A 35 = UPC E 36 = CODABAR 37 = Code 128 38 = EAN ADD ON 39 = GS1-128 (EAN 128) 40 = Code 93 41 = PZN 42 = 2/5 Industrie 43 = Leitcode 44 = Identcode 46 = Code 39 extended 47 = Code 128 A 48 = Code 128 B 49 = Pharmacode
d	rotation 0 = 0° 1 = 90° 2 = 180° 3 = 270°
h	height of symbol in 1/100 mm
v1	relation 1; module width 'THICK'
v2	relation 2; module width 'THIN' res. SC factor
pz	check digit calculation 0 = no check digit calculation 1 = check digit calculation 4 = inverse - no check digit calculation 5 = inverse - check digit calculation
z	human readable line 0 = no human readable line 1 = with human readable line
dp	datumpoint 1 = left top 2 = centre top 3 = right top 4 = left centre 5 = centre centre 6 = right centre 7 = left bottom (default) 8 = centre bottom 9 = right bottom

ITF Code

AM[n]y;x;p;a;d;h;v1;v2;pz;z;dp	
A	identification for mask set
M	identification for protocol version
n	field number
y	Y position in 1/100 mm
x	X position in 1/100 mm
p	identification for phantom field 0 = print - 1 = no print
a	identification for field type 56 = ITF 14
d	rotation 0 = 0° 1 = 90° 2 = 180° 3 = 270°
h	height of symbol in 1/100 mm
v1	relation 1; module width 'THICK'
v2	relation 2; module width 'THIN' res. SC factor
pz	check digit calculation 0 = no check digit calculation 1 = check digit calculation 4 = inverse - no check digit calculation 5 = inverse - check digit calculation
z	human readable line 0 = no human readable line 1 = with human readable line
dp	datapoint 1 = left top 2 = centre top 3 = right top 4 = left centre 5 = centre centre 6 = right centre 7 = left bottom (default) 8 = centre bottom 9 = right bottom

In order to print the bearer bars of an ITF 14 barcode, the following additional properties for Code 2/5 interleaved must be set:

For this the following field properties are determined:

Property identifier	Description
BT	bearer bar type 0 = no bars 1 = above/below 2 = rectangle
BW	bearer bar width in 1/100 mm
QZ	quiet zone in 1/100 mm

Example

```
// BARCODE (1/100 mm)
(SOH)AM[1]4498;7076;0;31;2;3000;12;4;0;1;3(ETB)
(SOH)AC[1]BT=2;BW=150;QZ=600(ETB)
(SOH)BM[1]1234567890123(ETB)
```



2D bar codes

PDF417

AM[n;y;x;p;a;d;s;rw;rh;ec;z;dp;c;r	
A	identification for mask set
M	identification for protocol version
n	field number
y	Y position in 1/100 mm
x	X position in 1/100 mm
p	identification for phantom field 0 = print 1 = no print
a	identification for field type 50 = PDF417
d	rotation 0 = 0° 1 = 90° 2 = 180° 3 = 270°
s	symbol size
rw	relation width
rh	relation height
ec	error correction level 0 - ECC Level = 0 1 - ECC Level = 2 2 - ECC Level = 6 3 - ECC Level = 14 4 - ECC Level = 30 5 - ECC Level = 62 6 - ECC Level = 126 7 - ECC Level = 254 8 - ECC Level = 510
z	style 0 = Standard 1 = Truncated 2 = Naked 3 = Bare
dp	datapoint 1 = left top 2 = centre top 3 = right top 4 = left centre 5 = centre centre 6 = right centre 7 = left bottom (default) 8 = centre bottom 9 = right bottom
c	number of columns 0 = automatic, 1-30
r	number of rows 0 = automatic, 3-90

MAXICODE

AM[n]y;x;p;a;d;0;sn;ns;m;0;dp	
A	identification for mask set
M	identification for protocol version
n	field number
y	Y position in 1/100 mm
x	X position in 1/100 mm
p	identification for phantom field 0 = print 1 = no print
a	identification for field type 51 = MAXICODE
d	rotation 0 = 0° 1 = 90° 2 = 180° 3 = 270°
0	dummy
sn	symbol number
ns	quantity of symbols
m	mode 2 = Structured Message (US Carrier) 3 = Structured Message (International Carrier) 4 = Default message
0	dummy
dp	datumpoint 1 = left top 2 = centre top 3 = right top 4 = left centre 5 = centre centre 6 = right centre 7 = left bottom (default) 8 = centre bottom 9 = right bottom

DataMatrix

AM[n;y;x;p;a;d;s;aw;ah;ec;f;dp																															
A	identification for mask set																														
M	identification for phantom field																														
n	field number																														
y	Y position in 1/100 mm																														
x	X position in 1/100 mm																														
p	identification for phantom field 0 = print; 1 = no print																														
a	identification for field type 52 = DataMatrix																														
d	rotation 0 = 0° 1 = 90° 2 = 180° 3 = 270°																														
s	symbol size in 1/100 mm																														
aw	relation width																														
ah	relation height																														
ec	error correction <table border="0"> <tr> <td>0 - ECC Type = 0</td> <td>ECC Level = 0</td> <td>Overhead = 0 %</td> </tr> <tr> <td>1 - ECC Type = 2*</td> <td>ECC Level = 40</td> <td>Overhead = 33 %</td> </tr> <tr> <td>2 - ECC Type = 3</td> <td>ECC Level = 50</td> <td>Overhead = 25 %</td> </tr> <tr> <td>3 - ECC Type = 6</td> <td>ECC Level = 80</td> <td>Overhead = 33 %</td> </tr> <tr> <td>4 - ECC Type = 8</td> <td>ECC Level = 100</td> <td>Overhead = 50 %</td> </tr> <tr> <td>5 - ECC Type = 9*</td> <td>ECC Level = 110</td> <td>Overhead = 75 %</td> </tr> <tr> <td>6 - ECC Type = 10*</td> <td>ECC Level = 120</td> <td>Overhead = 50 %</td> </tr> <tr> <td>7 - ECC Type = 11*</td> <td>ECC Level = 130</td> <td>Overhead = 67 %</td> </tr> <tr> <td>8 - ECC Type = 12</td> <td>ECC Level = 140</td> <td>Overhead = 75 %</td> </tr> <tr> <td>9 - ECC Type = 26</td> <td>ECC Level = 200</td> <td>Overhead = 0 %</td> </tr> </table>	0 - ECC Type = 0	ECC Level = 0	Overhead = 0 %	1 - ECC Type = 2*	ECC Level = 40	Overhead = 33 %	2 - ECC Type = 3	ECC Level = 50	Overhead = 25 %	3 - ECC Type = 6	ECC Level = 80	Overhead = 33 %	4 - ECC Type = 8	ECC Level = 100	Overhead = 50 %	5 - ECC Type = 9*	ECC Level = 110	Overhead = 75 %	6 - ECC Type = 10*	ECC Level = 120	Overhead = 50 %	7 - ECC Type = 11*	ECC Level = 130	Overhead = 67 %	8 - ECC Type = 12	ECC Level = 140	Overhead = 75 %	9 - ECC Type = 26	ECC Level = 200	Overhead = 0 %
0 - ECC Type = 0	ECC Level = 0	Overhead = 0 %																													
1 - ECC Type = 2*	ECC Level = 40	Overhead = 33 %																													
2 - ECC Type = 3	ECC Level = 50	Overhead = 25 %																													
3 - ECC Type = 6	ECC Level = 80	Overhead = 33 %																													
4 - ECC Type = 8	ECC Level = 100	Overhead = 50 %																													
5 - ECC Type = 9*	ECC Level = 110	Overhead = 75 %																													
6 - ECC Type = 10*	ECC Level = 120	Overhead = 50 %																													
7 - ECC Type = 11*	ECC Level = 130	Overhead = 67 %																													
8 - ECC Type = 12	ECC Level = 140	Overhead = 75 %																													
9 - ECC Type = 26	ECC Level = 200	Overhead = 0 %																													
f	format ID 0 - Format ID = 11 (numeric, 2000 characters)* 1 - Format ID = 1 (numeric, 500 characters) 2 - Format ID = 2 (alphabetical, 500 characters) 3 - Format ID = 3 (alphabetical + pointers, 500 characters) 4 - Format ID = 4 (alphanumeric, 500 characters) 5 - Format ID = 5 (7 Bit, 500 characters) 6 - Format ID = 6 (8 Bit, 500 characters) 7 - Format ID = 7 (pre-programmed, 500 characters)* 8 - Format ID = 12 (alphabetical, 2000 characters) 9 - Format ID = 14 (alphanumeric, 2000 characters)																														
dp	datapoint 1 = left top 2 = centre top 3 = right top 4 = left centre 5 = centre centre 6 = right centre 7 = left bottom (default) 8 = centre bottom 9 = right bottom																														

* not supported from printer

CODABLOCK F

AM[n]y;x;p;a;d;h;nc;nl;m;s;dp	
A	identification for mask set
M	identification for protocol version
n	field number
y	Y position in 1/100 mm
x	X position in 1/100 mm
p	identification for phantom field 0 = print 1 = no print
a	identification for field type 53 = CODABLOCK F
d	rotation 0 = 0° 1 = 90° 2 = 180° 3 = 270°
h	height of line in symbole
nc	quantity of characters/line
nl	quantity of lines
m	mode
s	module size
dp	datapoint 1 = left top 2 = centre top 3 = right top 4 = left centre 5 = centre centre 6 = right centre 7 = left bottom (default) 8 = centre bottom 9 = right bottom

GS1 DataBar (RSS)

AM[n]y;x;p;a;d;s;m;k;t;0;dp	
A	identification for mask set
M	identification for protocol version
n	field number
y	Y position in 1/100 mm
x	X position in 1/100 mm
p	identification for phantom field 0 = print 1 = no print
a	identification for field type 54 = GS1 DataBar (RSS)
d	rotation 0 = 0° 1 = 90° 2 = 180° 3 = 270°
s	number of segments per line [2...22]
m	module width [1 ... 12]
k	spacing correction [0,1,2]
t	symbol type 1 = GS1 DataBar Omnidirectional (RSS-14) 2 = GS1 DataBar Truncated (RSS-14 Truncated) 3 = GS1 DataBar Stacked (RSS-14 Stacked) 4 = GS1 DataBar Stacked Omnidirectional (RSS-14 Stacked Omnidirectional) 5 = GS1 DataBar Limited (RSS Limited) 6 = GS1 DataBar Expanded (RSS Expanded)
z	not in use
dp	datapoint 1 = left top 2 = centre top 3 = right top 4 = left centre 5 = centre centre 6 = right centre 7 = left bottom (default) 8 = centre bottom 9 = right bottom

QR Code

AM[n];y;x;p;a;d;mo;cs;ms;cw;ec;dp	
A	identification for mask set
M	identification for protocol version
n	field number
y	Y position in 1/100 mm
x	X position in 1/100 mm
p	identification for phantom field 0 = print 1 = no print
a	identification for field type 57 = QR Code
d	rotation 0 = 0° 1 = 90° 2 = 180° 3 = 270°
mo	code model 1 = code model 1 2 = code model 2
cs	character set N = numeric A = alphanumeric B = 8-bit Byte K = Kanji
ms	masking -1 = auto 0-7 = mask x 8 = no masking
cw	line width in 1/100 mm per module possible values: 0-800
ec	error correction (restoring capacity) L = 7% M = 15% Q = 25% H = 30%
dp	datapoint 1 = left top 2 = centre top 3 = right top 4 = left centre 5 = centre centre 6 = right centre 7 = left bottom (default) 8 = centre bottom 9 = right bottom

Rectangle

AM[n]y;x;p;a;h;b;s;m;dp	
A	identification for mask set
M	identification for protocol number
n	field number
y	Y position in 1/100 mm
x	X position in 1/100 mm
p	identification for phantom field 0 = print 1 = no print
a	identification for field type 10 = rectangle
h	height of rectangle in 1/100 mm
b	width of rectangle in 1/100 mm
s	line width in 1/100 mm
m	line style; 1 digit
dp	Datumpoint 1 = left top 2 = centre top 3 = right top 4 = left centre 5 = centre centre 6 = right centre 7 = left bottom (default) 8 = centre bottom 9 = right bottom

Line

AM[n]y;x;p;a;d;l;s;m;dp	
A	identification for mask set
M	identification for protocol version
n	field number
y	Y position in 1/100 mm
x	X position in 1/100 mm
p	identification for phantom field 0 = print 1 = no print
a	identification for field type 11 = line
d	rotation 0 = horizontal 1 = vertical
l	length in 1/100 mm
s	line width in 1/100 mm
m	line style, 1 digit
dp	datumpoint 1 = left top 2 = centre top 3 = right top 4 = left centre 5 = centre centre 6 = right centre 7 = left bottom (default) 8 = centre bottom 9 = right bottom

Internal graphic

AM[n]y;x;p;a;d;dy;dx;dp	
A	identification for mask set
M	identification for protocol version
n	field number
y	Y position in 1/100 mm
x	X position in 1/100 mm
p	identification for phantom field 0 = print 1 = no print
a	identification for field type 3 = internal graphic
d	rotation 0 = 0° 1 = 90° 2 = 180° 3 = 270°
dy	extension in direction Y
dx	extension in direction X
dp	datumpoint 1 = left top 2 = centre top 3 = right top 4 = left centre 5 = centre centre 6 = right centre 7 = left bottom (default) 8 = centre bottom 9 = right bottom

TEXT SET

BM[n]text	
B	identification for text set
M	identification for extended protocol
n	field number
text	data contents, text

BV[n]text	
B	identification for text set
V	identification for selection by field name
n	field name
text	data contents, text

BF[n]text	
B	identification for text set
F	identification for selection by free definable field number
n	field number
text	data contents, text

Examples

Mask statement [SOH]AM[1]2000;4000;0;1;0;2;1;1;0[ETB]

field number
y position 20 mm
x position 40 mm
no phantom field
bitmap font
position 0
font 2
extension in y direction 1
extension in x direction 1
no blank pixel

Text statement [SOH]BM[1]this is a test [ETB]

field number 1
text "this is a test"

text set with variable definition: [SOH]BM[125]=CN(0,0,3,1,1)000[ETB]

Example label

ASCII data	Identification
⊗AM[1]3600;4600;0;33;0;1500;0;4;1;1⊕ ^C _R ^L _F	mask set for bar code
⊗BM[1]444444444444⊕ ^C _R ^L _F	appropriate text set
⊗AM[2]600;4700;0;4;0;1;300;200;24⊕ ^C _R ^L _F	five mask sets vector font / proportional font
⊗AM[3]600;3100;0;4;0;1;400;300;24⊕ ^C _R ^L _F	
⊗AM[4]1100;4700;0;4;0;1;400;300;24⊕ ^C _R ^L _F	
⊗AM[5]1800;4700;0;4;0;1;300;200;24⊕ ^C _R ^L _F	
⊗AM[6]1900;3700;0;4;0;1;600;400;24⊕ ^C _R ^L _F	
⊗BM[2]Art.Nr. ⊕ ^C _R ^L _F	five appropriate text sets
⊗BM[3]44444⊕ ^C _R ^L _F	
⊗BM[4]Artikelbezeichnung⊕ ^C _R ^L _F	
⊗BM[5]DM⊕ ^C _R ^L _F	
⊗BM[6]99,-- ⊕ ^C _R ^L _F	
⊗FBA000r06000000⊕	number of lines
⊗FBBA00r00001000⊕	number of items
⊗FBC000r00000000⊕	start

: graphic data in PCX format
 ⊗: SOH (1_{hex} bzw 5E_{hex})
 ⊕: ETB (17_{hex} bzw. 5F_{hex})
^C: CarriageReturn (0D_{hex})
^L_F: LineFeed (0A_{hex})

GRAPHIC

General graphic format

This format is supported by all our printers but note that a 8 bit transmission is absolute necessary.

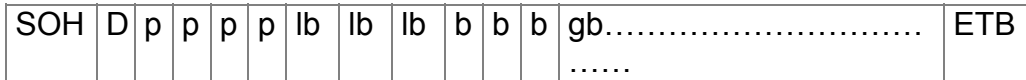

			min.	max.
D	=	identification for graphic set		
p	=	pixel line from above	'0000'	'1900'
lb	=	1. byte from left	'000'	'100'
b	=	quantity of bytes	'1'	'100'
gb	=	graphic bytes		

Graphic byte:



1 graphic bit = 0,083 x 0,083 mm

Graphic in PCX format

It is possible to transfer graphic data as a PCX-file (e.g. PaintBrush) to the printer. With this type of data transfer the PCX-file is transferred in a compressed form. Hereby the RLE-procedure is used and therefore the graphic data were reduced by approx. 30 %. This means that the effective transferring time for 300 dpi printers is cut in halves.

To set the printer ready for receiving PCX-data the protocol has to be switched over and hereby the following command set will be defined:

SOH	A	X	n	n	n	y	y	y	y	y	x	x	x	x	x	x	m	dp	ETB
-----	---	---	---	---	---	---	---	---	---	---	---	---	---	---	---	---	---	----	-----

n	Index of transferred graphic to printer internal maintenance at present not processed (000)		
y	Y coordinate of graphic in 1/100 mm		
x	X coordinate of graphic in 1/100 mm		
m	Mode 0 = standard	-	background is overwritten
	Mode 1 = transparency	-	background is maintained
	Mode 2 = inverse	-	background is overwritten
	Mode 3 = inverse transparency	-	background is maintained
dp	Datumpoint		
	1 = left top	2 = centre top	3 = right top
	4 = left centre	5 = centre centre	6 = right centre
	7 = left bottom (default)	8 = centre bottom	9 = right bottom

- It is recommended to observe that directly after the final sign (ETB) no separator res. fill character such as $C_R^L F$ is indicated.
- The printer supports the following PCX versions: 5, 3, 2 and 0.
- It is necessary that the corresponding PCX-file is available as monochrome (black/white).
- The graphic has to be available in the original size as the printer is not able to change the size by itself.

Before print start, indicated by parameter set 'FBC', the definition of field number, lines and pieces has to be effected via the parameter sets (FBA res. FBB).

Example of PCX file

-*** PCX_GRAPHIC-INFO ***-	
⊗AX0010015300100941⊕#####	
⊗AM[1]3600;4600;0;33;0;1500;0;4;1;1⊕ ^C _R ^L _F	mask set for bar code
⊗BM[1]444444444444⊕ ^C _R ^L _F	appropriate text set
⊗AM[2]600;4700;0;4;0;1;300;200;24⊕ ^C _R ^L _F ⊗AM[3]600;3100;0;4;0;1;400;300;24⊕ ^C _R ^L _F ⊗AM[4]1100;4700;0;4;0;1;400;300;24⊕ ^C _R ^L _F ⊗AM[5]1800;4700;0;4;0;1;300;200;24⊕ ^C _R ^L _F ⊗AM[6]1900;3700;0;4;0;1;600;400;24⊕ ^C _R ^L _F	five mask set vector font / proportional font
⊗BM[2]Art.Nr. ⊕ ^C _R ^L _F ⊗BM[3]44444⊕ ^C _R ^L _F ⊗BM[4]Artikelbezeichnung⊕ ^C _R ^L _F ⊗BM[5]DM⊕ ^C _R ^L _F ⊗BM[6]99,-- ⊕ ^C _R ^L _F	Five appropriate text sets
⊗FBA00r06000000⊕	set number of lines (FBA...)
⊗FBBA00r00001000⊕	set quantity (FBBA...)
⊗FBC000r00000000⊕	start print order (FBC...)

: graphic data in PCX format

⊗: SOH (1_{hex} bzw 5E_{hex})

⊕: ETB (17_{hex} bzw. 5F_{hex})

^C_R: CarriageReturn (0D_{hex})

^L_F: LineFeed (0A_{hex})

VARIABLES

Set structure

SOH	BM	[n]	=	v	v	(p1	p2	p	pn)	t1	t2	t	t70	ETB
-----	----	-----	---	---	---	---	----	----	---	----	---	----	----	---	-----	-----

The grey marked part corresponds to the variable definition. The text entered from t1 to t70 is added to the function result of variable.

= start of function

vv variable type
 SC link field
 CN counter
 CC extended counter
 CU currency variable

(start of variable parameter block

p1...pn variable parameter

) end of variable parameter block

Note: In case you want to print a text which corresponds exactly to the variable definition then you have to place '!' before.

SOH	BM	[n]	!	=	v	v	(p1	p2	p	pn)	t1	t2	t	t70	ETB
-----	----	-----	---	---	---	---	---	----	----	---	----	---	----	----	---	-----	-----

Link field

SOH	BM	[n]	=	S	C	(p1	;	p2	;	p	;	pn)	t1	t2	t	t70	ETB
-----	----	-----	---	---	---	---	----	---	----	---	---	---	----	---	----	----	---	-----	-----

= SC identification of link field

p1...pn identification of link elements (field number or constant text)
 field number is entered without leading '0'
 constant text is included in " but these marks are not printed

Note: Reference fields can be constant text or variables but no link fields.

Example: = SC (1; 2; 3) print: field1field2field3
 = SC (1;"constant"; 2) print: field1constantfield2

Counter

SOH	BM	[n]	=	C	N	(t	;	m	;	c	;	+/-	s	;	i	;	h	;	r)	t1	t2	t	t70	ETB
																							...			

= CN identification counter

t type of counter
 0 numerical
 1 letters only
 2...36 radix, base of the counter

m function mode of counter
 0 standard
 1 return to start value
 2 enter the start value at the beginning of printing
 (default = existing start value)
 3 enter the start value at the beginning of printing
 (default = last final number)
 4 reset start value at cycle end
 (only for DPM IIIi)
 5 reset start value by I/O signal
 6 time-controlled resetting
 7 time-controlled resetting with input of initial value
 (default = last final value)

c digit where the numbering starts counting

+/- direction
 + adding
 - subtracting

s step width

i update interval
 (number of labels with identical number)

h time by which the counter is reset (function mode 6 and 7) in format 'HH:MM'
 e.g. 00:00 = reset counter at 0:00
 (optional, only for function mode 6 and 7)

r reset value
 (optional, only for function mode 6 and 7; default = text and/or initial value)

Limitation:

The time-controlled resetting of counter variable is only effected in case of an active print order. If a print order is cancelled before the specified time and afterwards again restarted then no resetting of counter value is effected.

t1, t2, ... text res. start value of counter

Example:

Entry: = CN (10;7;4;+1;1;06:00;0001)1234

The enquiry for the initial value is effected at print start and at 6:00 the counter variable is reset to value 0001.

Extended counter

SOH	BM	[n]	=	C	C	(+/-	s	;	i	;	m	;	z	;	n	;	x)	t	ETB
-----	----	-----	---	---	---	---	-----	---	---	---	---	---	---	---	---	---	---	---	---	---	-----

= CC	identification of numeric counter
+/-	direction
+	counter adding
-	counter subtracting
s	step width
i	update interval (number of labels with identical number)
m	function mode of counter
0	standard
1	return to start value
2	enter the start value at the beginning of printing (default = existing start value)
3	enter the start value at the beginning of printing (default = last final number)
4	reset start value at cycle end (only for DPM IIIi)
5	set min. / max. value
6	set start value
7	print end
z	leading zeros
0	no leading zeros
1	printout with leading zeros
n	minimum value (max. -999999999)
x	maximum value (max. 999999999)
t	start value (the number of digits determines the format for the printout with leading zeros (max. 999999999))

Example:

Entry: = CC (+1;2;5;0;1,999)0050

Print: 50, 51,...999, 1, 2, ...

Currency variable

SOH	B	n	n	=	C	U	(a	;	b	;	c	;	d	;	e	;	f	;	g)	t1	t2	t	t70	ETB
-----	---	---	---	---	---	---	---	---	---	---	---	---	---	---	---	---	---	---	---	---	---	----	----	---	-----	-----

- = CU Signification of variable Euro
- a ANSI-Code of thousand separator as decimal figure
- b ANSI-Code of comma separator as decimal figure
- c Quantity of numbers after the comma as decimal figure
- d Operand A Before the processing the variable Euro calculates the term
- e Operand B $\frac{A \times B}{C}$
- f Operand C
- g Rounding format
- t1, t2, ... Format string, is indicated by "< >"

Example:

In case the contents of field 20 has to be converted from USD into EUR the definition of variable for the user defined format is as follows:

B01 "=CU(46;44;2;20;"1,0";"0,68861";"0,01")Result: <>Euro"
 B20 1.250,44 USD

Printout: 1.250,44 USD
 Result: 1.815,89 Euro *

GS1-128 (EAN 128) Parser

Note: By means of this variable type, the content of an application identifier in a GS1-128 bar code can be determined.

SOH	BM	[n]	=	A	I	(p	;	Ai)	ETB
-----	----	-----	---	---	---	---	---	---	----	---	-----

- = AI identification of GS1-128 parser
- p identification of the link element (field number)
- Ai application identifier

Example: Field 1 ="00123456789012345675" GS1-128 with AI00
 = AI (1;"00") Printout: 123456789012345675

* 1 USD = 0,68861 Euro (11.01.2010)

EPC calculation (Electronic Product Code)*

SOH BM [n] = E P C (M ; L ; F ; P ; N1 ; {N2}) ETB

= EPC identification of EPC calculation Kennung EPC Berechnung

M coding method
 L length of manufacturer number (company prefix)
 F filter value
 P verification of check digit
 N1 identification of link element (field number)
 N2 identification of link element (field number) - optional

Note: For more information, visit the following web sites: www.epcglobalinc.org or www.gs1.org

Parameter	Value range		
M	0 = Coding method SSCC96		3 = Coding method GRAI96
	1 = Coding method SGTIN96		4 = Coding method GIAI96
	2 = Coding method SGLN96		
L	6...12		
F	Coding	Filter value	Binary value
	SSCC96	All Others	000
		Undefined	001
		Logistical / Shipping Unit	010
	SGTIN96	All Others	000
		Retail Consumer Trade Item	001
		Standard Trade Item Grouping	010
		Single Shipping / Consumer Trade Item	011
	SGLN	All Others	000
		Physical Location	001
	GRAI	All Others	000
	GIAI	All Others	000
P	0 = no verification; 1 = verification of check digit		
N1	any		
N2	any		

Example 1: Field 1 = "00123456789012345675" GS1-128 with AI00
 Field 2 = AI (1;"00") Printout: 123456789012345675
 Field 3 = EPC(0;12;0;1;2) Printout: 3100DA7557D32C38E7000000

The EPC is calculated with the content of Field 2. The coding method SSCC96 is used. In Field 2 a valid NVE must be represented (18-digit, correct check digit).

Example 2: Field 1 = "4141234567890128254123" GS1-128 with AI00, AI254
 Field 2 = AI (1;"414") Printout: 1234567890128
 Field 3 = AI (1;"254") Printout: 123
 Field 4 = EPC(2;10;0;0;2;3) Printout: 3208499602D218000000007B

The EPC is calculated with the content of Field 2 and Field 3. The coding method SGLN96 is used. In Field 2 a valid ILN must be represented (13-digit). In the example, Field 3 contains an optional serial number. No verification of check digit of ILN (8) is effected.

* only when using option RFID

PARAMETER SETS

Label parameter

Set label photocell type

SOH	F	C	D	E	-	-	r	N	-	-	-	-	-	-	-	-	ETB
-----	---	---	---	---	---	---	---	---	---	---	---	---	---	---	---	---	-----

N = 0 – transmission photocell normal

N = 1 – reflection photocell

Enquire label photocell type

SOH	F	C	D	E	-	-	w	p	p	p	p	p	p	p	p	p	ETB
-----	---	---	---	---	---	---	---	---	---	---	---	---	---	---	---	---	-----

Answer

SOH	A	N	-	-	-	-	-	-	-	p	p	p	p	p	p	p	p	ETB
-----	---	---	---	---	---	---	---	---	---	---	---	---	---	---	---	---	---	-----

Set label type

SOH	F	C	D	A	-	-	r	N	-	-	-	-	-	-	-	-	ETB
-----	---	---	---	---	---	---	---	---	---	---	---	---	---	---	---	---	-----

N = 0 – selection of adhesive labels (automatical measure process)

N = 1 – selection of continuous labels

Enquire label type

SOH	F	C	D	A	-	-	w	p	p	p	p	p	p	p	p	p	p	ETB
-----	---	---	---	---	---	---	---	---	---	---	---	---	---	---	---	---	---	-----

Answer

SOH	A	N	-	-	-	-	-	-	-	p	p	p	p	p	p	p	p	ETB
-----	---	---	---	---	---	---	---	---	---	---	---	---	---	---	---	---	---	-----

Measure label

In case of loading a new label roll it is possible to start measuring by this command.

SOH	F	C	B	-	-	-	r	-	-	-	-	-	-	-	-	-	ETB
-----	---	---	---	---	---	---	---	---	---	---	---	---	---	---	---	---	-----

The current label and gap length in the printer can be send to the Host computer:

SOH	F	C	B	-	-	-	w	p	p	p	p	p	p	p	p	p	ETB
-----	---	---	---	---	---	---	---	---	---	---	---	---	---	---	---	---	-----

After this command the printer sends the following answer:

Answer

SOH	A	E	E	E	E	S	S	S	S	p	p	p	p	p	p	p	p	ETB
-----	---	---	---	---	---	---	---	---	---	---	---	---	---	---	---	---	---	-----

EEEE indicates the label length in mm (ASCII)

SSSS indicates the gap length in mm (ASCII)

Set label length in 1/100 mm

SOH	F	C	C	L	-	-	r	N	N	N	N	N	N	N	-	ETB
-----	---	---	---	---	---	---	---	---	---	---	---	---	---	---	---	-----

N: value of label length in 1/100 mm, 7 digit ASCII number

Enquire label length in 1/100 mm

SOH	F	C	C	L	-	-	w	N	N	N	N	N	N	N	-	ETB
-----	---	---	---	---	---	---	---	---	---	---	---	---	---	---	---	-----

Answer

SOH	A	N	N	N	N	N	N	N	-	p	p	p	p	p	p	p	ETB
-----	---	---	---	---	---	---	---	---	---	---	---	---	---	---	---	---	-----

Set gap length in 1/100 mm

SOH	F	C	C	M	-	-	r	M	M	M	M	M	-	-	-	ETB
-----	---	---	---	---	---	---	---	---	---	---	---	---	---	---	---	-----

M: value of gap length in 1/100 mm, 5 digit ASCII number

Enquire gap length in 1/100 mm abfragen

SOH	F	C	C	M	-	-	w	M	M	M	M	M	-	-	-	ETB
-----	---	---	---	---	---	---	---	---	---	---	---	---	---	---	---	-----

Answer

SOH	A	M	M	M	M	M	M	-	-	-	p	p	p	p	p	p	ETB
-----	---	---	---	---	---	---	---	---	---	---	---	---	---	---	---	---	-----

Set label width in 1/100 mm

SOH	F	C	C	O	-	-	r	N	N	N	N	N	N	N	ETB
-----	---	---	---	---	---	---	---	---	---	---	---	---	---	---	-----

N: indication of label width in 1/100 mm, 7 digit ASCII number

Enquire label width in 1/100 mm

SOH	F	C	C	O	-	-	w	P	P	P	P	P	P	P	P	ETB
-----	---	---	---	---	---	---	---	---	---	---	---	---	---	---	---	-----

Answer

SOH	A	N	N	N	N	N	N	N	-	p	p	p	p	p	p	p	ETB
-----	---	---	---	---	---	---	---	---	---	---	---	---	---	---	---	---	-----

Set label error length

SOH	F	C	D	G	A	-	r	N	N	N	N	-	-	-	-	ETB
-----	---	---	---	---	---	---	---	---	---	---	---	---	---	---	---	-----

NNNN = Indication of label error length in mm (1-9999)

Enquire label error length

SOH	F	C	D	G	A	-	w	p	p	p	p	p	p	p	p	ETB
-----	---	---	---	---	---	---	---	---	---	---	---	---	---	---	---	-----

Answer

SOH	A	N	N	N	N	-	-	-	-	p	p	p	p	p	p	p	ETB
-----	---	---	---	---	---	---	---	---	---	---	---	---	---	---	---	---	-----

Set label synchronisation

SOH	F	C	D	G	B	-	r	N	-	-	-	-	-	-	-	-	ETB
-----	---	---	---	---	---	---	---	---	---	---	---	---	---	---	---	---	-----

N = 0 – Off

N = 1 – On

Enquire lable synchronisation

SOH	F	C	D	G	B	-	w	p	p	p	p	p	p	p	p	p	ETB
-----	---	---	---	---	---	---	---	---	---	---	---	---	---	---	---	---	-----

Answer

SOH	A	N	-	-	-	-	-	-	-	p	p	p	p	p	p	p	ETB
-----	---	---	---	---	---	---	---	---	---	---	---	---	---	---	---	---	-----

Set number of columns

SOH	F	C	C	H	A	-	r	N	-	-	-	-	-	-	-	ETB
-----	---	---	---	---	---	---	---	---	---	---	---	---	---	---	---	-----

N = number of columns (1...9)

Enquire number of columns

SOH	F	C	C	H	A	-	w	p	p	p	p	p	p	p	p	p	ETB
-----	---	---	---	---	---	---	---	---	---	---	---	---	---	---	---	---	-----

Answer

SOH	A	N	-	-	-	-	-	-	-	p	p	p	p	p	p	p	ETB
-----	---	---	---	---	---	---	---	---	---	---	---	---	---	---	---	---	-----

Set column width

SOH	F	C	C	H	B	-	r	N	N	N	-	-	-	-	-	ETB
-----	---	---	---	---	---	---	---	---	---	---	---	---	---	---	---	-----

NNN: indication of column width in 1/10 mm (0...999)

Enquire column width

SOH	F	C	C	H	B	-	w	p	p	p	p	p	p	p	p	ETB
-----	---	---	---	---	---	---	---	---	---	---	---	---	---	---	---	-----

Answer

SOH	A	N	N	N	-	-	-	-	-	p	p	p	p	p	p	p	ETB
-----	---	---	---	---	---	---	---	---	---	---	---	---	---	---	---	---	-----

Set label alignment

SOH	F	C	C	J	-	-	r	N	-	-	-	-	-	-	-	ETB
-----	---	---	---	---	---	---	---	---	---	---	---	---	---	---	---	-----

N = 1: centre

Enquire label alignment

SOH	F	C	C	J	-	-	w	p	p	p	p	p	p	p	p	ETB
-----	---	---	---	---	---	---	---	---	---	---	---	---	---	---	---	-----

Answer

SOH	A	N	-	-	-	-	-	-	-	p	p	p	p	p	p	p	ETB
-----	---	---	---	---	---	---	---	---	---	---	---	---	---	---	---	---	-----

Set contrast

SOH	F	C	A	B	-	-	r	N	N	N	-	-	-	-	-	ETB
-----	---	---	---	---	---	---	---	---	---	---	---	---	---	---	---	-----

NNN: Indication of contrast in % (010...200) - It is necessary to transmit a 3 digit ASCII number

Enquire contrast

SOH	F	C	A	B	-	-	w	p	p	p	p	p	p	p	p	ETB
-----	---	---	---	---	---	---	---	---	---	---	---	---	---	---	---	-----

Answer

SOH	A	N	N	N	-	-	-	-	-	p	p	p	p	p	p	p	ETB
-----	---	---	---	---	---	---	---	---	---	---	---	---	---	---	---	---	-----

Set flip label

SOH	F	C	D	O	-	-	r	N	-	-	-	-	-	-	-	ETB
-----	---	---	---	---	---	---	---	---	---	---	---	---	---	---	---	-----

N = 0 – flip label Off N = 1 – flip label On

Enquire flip label

SOH	F	C	D	O	-	-	w	p	p	p	p	p	p	p	p	ETB
-----	---	---	---	---	---	---	---	---	---	---	---	---	---	---	---	-----

Answer

SOH	A	N	-	-	-	-	-	-	-	p	p	p	p	p	p	p	ETB
-----	---	---	---	---	---	---	---	---	---	---	---	---	---	---	---	---	-----

Set label rotation

SOH	F	C	D	N	-	-	r	X	-	-	-	-	-	-	-	ETB
-----	---	---	---	---	---	---	---	---	---	---	---	---	---	---	---	-----

X = 0 – rotate label Off X = 1 – rotate label On

Enquire label rotation

SOH	F	C	D	N	-	-	w	p	p	p	p	p	p	p	p	ETB
-----	---	---	---	---	---	---	---	---	---	---	---	---	---	---	---	-----

Answer

SOH	A	X	-	-	-	-	-	-	-	p	p	p	p	p	p	p	ETB
-----	---	---	---	---	---	---	---	---	---	---	---	---	---	---	---	---	-----

Set operating mode flip/rotate label

SOH	F	C	D	S	-	-	r	N	-	-	-	-	-	-	-	ETB
-----	---	---	---	---	---	---	---	---	---	---	---	---	---	---	---	-----

N = 0 – flip/rotate label at the centre point of label
 N = 1 – flip/rotate label at the centre point of printhead

Enquire operating mode flip/rotate label

SOH	F	C	D	S	-	-	w	p	p	p	p	p	p	p	p	ETB
-----	---	---	---	---	---	---	---	---	---	---	---	---	---	---	---	-----

Answer

SOH	A	N	-	-	-	-	-	-	-	p	p	p	p	p	p	p	ETB
-----	---	---	---	---	---	---	---	---	---	---	---	---	---	---	---	---	-----

Set scan position

SOH	F	C	D	E	A	-	r	N	N	-	-	-	-	-	-	ETB
-----	---	---	---	---	---	---	---	---	---	---	---	---	---	---	---	-----

NN = Indication of set label length in % (01-99)
 This value depends on the label length.

Enquire scan position

SOH	F	C	D	E	A	-	w	p	p	p	p	p	p	p	p	ETB
-----	---	---	---	---	---	---	---	---	---	---	---	---	---	---	---	-----

Answer

SOH	A	N	N	-	-	-	-	-	-	p	p	p	p	p	p	p	ETB
-----	---	---	---	---	---	---	---	---	---	---	---	---	---	---	---	---	-----

Label photocell

Enquire minimal measured level at label photocell

SOH	F	C	M	A	A	-	w	p	p	p	p	p	p	p	p	ETB
-----	---	---	---	---	---	---	---	---	---	---	---	---	---	---	---	-----

Answer

SOH	A	N	N	N	-	-	-	-	-	p	p	p	p	p	p	p	ETB
-----	---	---	---	---	---	---	---	---	---	---	---	---	---	---	---	---	-----

NNN: value of measured level, 3 digit ASCII number in 1/100 V

Enquire maximum measured level at label photocell

SOH	F	C	M	A	B	-	w	p	p	p	p	p	p	p	p	ETB
-----	---	---	---	---	---	---	---	---	---	---	---	---	---	---	---	-----

Answer

SOH	A	N	N	N	-	-	-	-	-	p	p	p	p	p	p	p	ETB
-----	---	---	---	---	---	---	---	---	---	---	---	---	---	---	---	---	-----

NNN: value of measured level, 3 digit ASCII number in 1/100 V

Set switching threshold of label photocell

SOH	F	C	M	A	C	-	r	N	N	N	-	-	-	-	-	ETB
-----	---	---	---	---	---	---	---	---	---	---	---	---	---	---	---	-----

NNN: value of switching threshold, 3 digit ASCII number in 1/100 V

This value is automatically calculated at measuring process at printer $(\min + \frac{\max - \min}{3})$

Enquire switching threshold

SOH	F	C	M	A	C	-	w	p	p	p	p	p	p	p	p	ETB
-----	---	---	---	---	---	---	---	---	---	---	---	---	---	---	---	-----

Answer

SOH	A	N	N	N	-	-	-	-	-	p	p	p	p	p	p	p	ETB
-----	---	---	---	---	---	---	---	---	---	---	---	---	---	---	---	---	-----

NNN: value at measured switching threshold, 3 digit ASCII number in 1/100 V

Enquire current value at set label photocell

SOH	F	C	M	B	B	-	w	p	p	p	p	p	p	p	p	ETB
-----	---	---	---	---	---	---	---	---	---	---	---	---	---	---	---	-----

Answer

SOH	A	N	N	N	-	-	-	-	-	p	p	p	p	p	p	p	ETB
-----	---	---	---	---	---	---	---	---	---	---	---	---	---	---	---	---	-----

NNN: value at label photocell, 3 digit ASCII number in 1/100 V

Dispensing photocell

Enquire condition of dispensing photocell

SOH	F	C	M	B	E	A	w	p	p	p	p	p	p	p	p	ETB
-----	---	---	---	---	---	---	---	---	---	---	---	---	---	---	---	-----

Answer

SOH	A	N	-	-	-	-	-	-	p	p	p	p	p	p	p	ETB
-----	---	---	---	---	---	---	---	---	---	---	---	---	---	---	---	-----

N = 0 – no label is at photocell

N = 1 – label is at photocell

The set switching threshold of dispensing photocell is taken into consideration.

Printer settings

Set print speed

SOH	F	C	A	A	-	-	r	N	N	N	-	-	-	-	-	ETB
-----	---	---	---	---	---	---	---	---	---	---	---	---	---	---	---	-----

NNN: Indication of print speed in mm/s
It is necessary to transmit a 3 digit ASCII number

Enquire speed

SOH	F	C	A	A	-	-	w	p	p	p	p	p	p	p	p	ETB
-----	---	---	---	---	---	---	---	---	---	---	---	---	---	---	---	-----

Answer

SOH	A	N	N	N	-	-	-	-	-	p	p	p	p	p	p	p	ETB
-----	---	---	---	---	---	---	---	---	---	---	---	---	---	---	---	---	-----

Set transfer ribbon control On/Off

SOH	F	C	D	B	-	-	r	N	M	-	-	-	-	-	-	ETB
-----	---	---	---	---	---	---	---	---	---	---	---	---	---	---	---	-----

N = 1 – transfer ribbon control Off
N = 0 – transfer ribbon control On

Enquire transfer ribbon control On/Off

SOH	F	C	D	B	-	-	w	p	p	p	p	p	p	p	p	ETB
-----	---	---	---	---	---	---	---	---	---	---	---	---	---	---	---	-----

Answer

SOH	A	N	M	-	-	-	-	-	-	p	p	p	p	p	p	p	ETB
-----	---	---	---	---	---	---	---	---	---	---	---	---	---	---	---	---	-----

Set field handling

SOH	F	C	D	K	-	-	r	N	-	-	-	-	-	-	-	ETB
-----	---	---	---	---	---	---	---	---	---	---	---	---	---	---	---	-----

N = 0 – field handling Off
N = 1 – graphic received
N = 2 – delete graphic

Enquire field handling

SOH	F	C	D	K	-	-	w	p	p	p	p	p	p	p	p	ETB
-----	---	---	---	---	---	---	---	---	---	---	---	---	---	---	---	-----

Answer

SOH	A	N	-	-	-	-	-	-	-	p	p	p	p	p	p	p	ETB
-----	---	---	---	---	---	---	---	---	---	---	---	---	---	---	---	---	-----

Set printer language

SOH	F	C	D	I	-	-	r	N	-	-	-	-	-	-	-	ETB
-----	---	---	---	---	---	---	---	---	---	---	---	---	---	---	---	-----

N = 0 – German
N = 1 – English
N = 2 – French

Enquire printer language

SOH	F	C	D	I	-	-	w	p	p	p	p	p	p	p	p	ETB
-----	---	---	---	---	---	---	---	---	---	---	---	---	---	---	---	-----

Answer

SOH	A	N	-	-	-	-	-	-	-	p	p	p	p	p	p	p	ETB
-----	---	---	---	---	---	---	---	---	---	---	---	---	---	---	---	---	-----

Set external printer parameter

SOH	F	C	C	P	-	-	r	N	-	-	-	-	-	-	-	-	ETB
-----	---	---	---	---	---	---	---	---	---	---	---	---	---	---	---	---	-----

N: 0 = parameter settings by interface are not taken into consideration

1 = parameter settings by interface are processed

Enquire external printer parameter

SOH	F	C	C	P	-	-	w	p	p	p	p	p	p	p	p	p	ETB
-----	---	---	---	---	---	---	---	---	---	---	---	---	---	---	---	---	-----

Answer

SOH	A	N	-	-	-	-	-	-	-	p	p	p	p	p	p	p	ETB
-----	---	---	---	---	---	---	---	---	---	---	---	---	---	---	---	---	-----

Set Codepage

SOH	F	C	C	N	-	-	r	N	-	-	-	-	-	-	-	-	ETB
-----	---	---	---	---	---	---	---	---	---	---	---	---	---	---	---	---	-----

N = 0 - ANSI

N = 1 - Codepage 437 (english)

N = 2 - Codepage 850

N = 3 - GEM German

N = 4 - GEM English

N = 5 - GEM French

N = 6 - GEM Swedish

N = 7 - GEM Danish

N = 8 - Codepage 437 (Greek)

N = 9 - Codepage 852 (Eastern European)

N = 10 - Codepage 857 (Turkish)

Enquire Codepage

SOH	F	C	C	N	-	-	w	p	p	p	p	p	p	p	p	p	ETB
-----	---	---	---	---	---	---	---	---	---	---	---	---	---	---	---	---	-----

Answer

SOH	A	N	-	-	-	-	-	-	-	p	p	p	p	p	p	p	ETB
-----	---	---	---	---	---	---	---	---	---	---	---	---	---	---	---	---	-----

Interface

You can set the parameter of the serial interface by the following commands but you have to note that after sending one of the commands also the host computer changes the corresponding parameter of its interface to allow further communications Host computer – printer.

For all interface commands the interface is fixed with x. Allowed are the following values:

x = 1 ⇒ COM 1

x = 2 ⇒ COM 2

In all other cases automatically the first serial interface is addressed.

In the answers the addressed interface is also returned.

Set all interface parameter

SOH	F	C	F	F	x	-	r	m	;	b	;	p	;	d	;	s	ETB
-----	---	---	---	---	---	---	---	---	---	---	---	---	---	---	---	---	-----

m = mode (0 = Off, 1 = On, 2 = On, without error message)

b = Baudrate (2400, 4800, 9600, 19200, 38400, 57600, 115200)

p = parity (n = no parity, e = even parity, o = odd parity)

d = number of data bits (7, 8)

s = number of stop bits (1, 2)

Enquire all interface parameter

SOH	F	C	F	F	x	-	w	p	p	p	p	p	p	p	p	p	ETB
-----	---	---	---	---	---	---	---	---	---	---	---	---	---	---	---	---	-----

Answer

SOH	A	x	;	m	;	b	;	p	;	d	;	s	;	p	p	p	p	p	p	p	p	p	ETB
-----	---	---	---	---	---	---	---	---	---	---	---	---	---	---	---	---	---	---	---	---	---	---	-----

Example: activate interface COM1 and set 9600 Baud, no parity, 8 data bits, 2 stop bits
[SOH]FCFF1-r1;9600;n;8;2[ETB]

Interface protocol

There are two different interface protocols available. Usually SOH = 01_{Hex} and ETB = 17_{Hex}. However there are host computers (e.g. AS/400), which can not work with these characters. Therefore you can switch SOH = 5E_{Hex} and ETB = 5F_{Hex}. The host computer has to change the corresponding parameter as well.

Set SOH and ETB

SOH	F	C	G	C	-	-	r	N	-	-	-	-	-	-	-	-	ETB
-----	---	---	---	---	---	---	---	---	---	---	---	---	---	---	---	---	-----

N = 0 - SOH = 01_{Hex}, ETB = 17_{Hex}

N = 1 - SOH = 5E_{Hex}, ETB = 5F_{Hex}

Enquire SOH and ETB

SOH	F	C	G	C	-	-	w	p	p	p	p	p	p	p	p	p	ETB
-----	---	---	---	---	---	---	---	---	---	---	---	---	---	---	---	---	-----

Answer

SOH	A	N	-	-	-	-	-	-	-	p	p	p	p	p	p	p	ETB
-----	---	---	---	---	---	---	---	---	---	---	---	---	---	---	---	---	-----

Data memory

Set data memory

SOH	F	C	G	D	-	-	r	M	-	-	-	-	-	-	-	-	ETB
-----	---	---	---	---	---	---	---	---	---	---	---	---	---	---	---	---	-----

M = 0 Off, after receiving FBCA0r or FBDA0r the interface is locked until the end of the print order, i.e. you cannot write more data in the receiving buffer.

M = 1 Standard, after starting a print order no data of the receiving buffer are processed but it is possible to write more data in the receiving buffer until it is full.

M = 2 Extended, after starting a print order it is possible to write more data in the receiving buffer. These data is processed during the print and the next label is prepared.

Enquire data memory

SOH	F	C	G	D	-	-	w	p	p	p	p	p	p	p	p	p	ETB
-----	---	---	---	---	---	---	---	---	---	---	---	---	---	---	---	---	-----

Answer

SOH	A	M	-	-	-	-	-	-	-	p	p	p	p	p	p	p	ETB
-----	---	---	---	---	---	---	---	---	---	---	---	---	---	---	---	---	-----

Set reaction to unknown interrogative set

SOH	F	C	G	E	A	-	r	N	-	-	-	-	-	-	-	ETB
-----	---	---	---	---	---	---	---	---	---	---	---	---	---	---	---	-----

N – Indication of value between 0 and 3

Enquire reaction to unknown interrogative set

SOH	F	C	G	E	A	-	w	p	p	p	p	p	p	p	p	p	ETB
-----	---	---	---	---	---	---	---	---	---	---	---	---	---	---	---	---	-----

Answer

SOH	A	N	-	-	-	-	-	-	-	p	p	p	p	p	p	p	ETB
-----	---	---	---	---	---	---	---	---	---	---	---	---	---	---	---	---	-----

Set port transmission

SOH	F	C	G	F	-	-	r	S	T	-	-	-	-	-	-	ETB
-----	---	---	---	---	---	---	---	---	---	---	---	---	---	---	---	-----

S - Source (indication of source port)

T - Target (indication of target source)

Port numbers: 1 - 6

Port number:

- 1 = COM1
- 2 = COM2 (depending on printer)
- 3 = LPT
- 4 = USB
- 5 = TCP (option)
- 6 = UDP (option)

Enquire port transmission

SOH	F	C	G	F	-	-	w	p	p	p	p	p	p	p	p	ETB
-----	---	---	---	---	---	---	---	---	---	---	---	---	---	---	---	-----

Answer

SOH	A	"	S1-T1	;	S2-T2	;	...	ID	:	p	p	p	p	p	p	p	"	ETB
-----	---	---	-------	---	-------	---	-----	----	---	---	---	---	---	---	---	---	---	-----

Offset values

Set zero point displacement (Offset 2)

SOH	F	C	C	D	-	-	r	V	N	N	N	-	-	-	-	ETB
-----	---	---	---	---	---	---	---	---	---	---	---	---	---	---	---	-----

V: pre-sign of offset (+ or -)

NNN: offset value, 3 digit ASCII number in 1/10 mm

Enquire zero point displacement (Offset 2)

SOH	F	C	C	D	-	-	w	p	p	p	p	p	p	p	p	ETB
-----	---	---	---	---	---	---	---	---	---	---	---	---	---	---	---	-----

Answer

SOH	A	V	N	N	N	-	-	-	-	p	p	p	p	p	p	p	ETB
-----	---	---	---	---	---	---	---	---	---	---	---	---	---	---	---	---	-----

Set displacement in direction X (Offset 3)

SOH	F	C	C	E	-	-	r	V	N	N	N	-	-	-	-	ETB
-----	---	---	---	---	---	---	---	---	---	---	---	---	---	---	---	-----

V: pre-sign of offset (+ or -)

NNN: offset value, 3 digit ASCII number in 1/10 mm

Enquire displacement in direction X (Offset 3)

SOH	F	C	C	E	-	-	w	p	p	p	p	p	p	p	p	ETB
-----	---	---	---	---	---	---	---	---	---	---	---	---	---	---	---	-----

Answer

SOH	A	V	N	N	N	-	-	-	-	p	p	p	p	p	p	p	ETB
-----	---	---	---	---	---	---	---	---	---	---	---	---	---	---	---	---	-----

Set tear off (Offset 4)

SOH	F	C	C	G	-	-	r	V	N	N	N	-	-	-	-	ETB
-----	---	---	---	---	---	---	---	---	---	---	---	---	---	---	---	-----

V: pre-sign of offset (always +)

NNN: offset value, 3 digit ASCII number in 1/10 mm

Enquire tear off (Offset 4)

SOH	F	C	C	G	-	-	w	p	p	p	p	p	p	p	p	ETB
-----	---	---	---	---	---	---	---	---	---	---	---	---	---	---	---	-----

Answer

SOH	A	V	N	N	N	-	-	-	-	p	p	p	p	p	p	p	ETB
-----	---	---	---	---	---	---	---	---	---	---	---	---	---	---	---	---	-----

Set cutter offset

SOH	F	C	S	C	A	-	r	V	N	N	N	-	-	-	-	ETB
-----	---	---	---	---	---	---	---	---	---	---	---	---	---	---	---	-----

V: pre-sign of offset (always +)

NNN: offset value, 3 digit ASCII number in 1/10 mm

Enquire cutter offset

SOH	F	C	S	C	A	-	w	p	p	p	p	p	p	p	p	p	ETB
-----	---	---	---	---	---	---	---	---	---	---	---	---	---	---	---	---	-----

Answer

SOH	A	V	N	N	N	-	-	-	-	p	p	p	p	p	p	p	-	ETB
-----	---	---	---	---	---	---	---	---	---	---	---	---	---	---	---	---	---	-----

Set dispenser offset

SOH	F	C	S	D	A	-	r	V	N	N	N	-	-	-	-	ETB
-----	---	---	---	---	---	---	---	---	---	---	---	---	---	---	---	-----

V: pre-sign of offset (always +)

NNN: offset value, 3 digit ASCII number in 1/10 mm

Enquire dispenser offset

SOH	F	C	S	D	A	-	w	p	p	p	p	p	p	p	p	p	ETB
-----	---	---	---	---	---	---	---	---	---	---	---	---	---	---	---	---	-----

Answer

SOH	A	V	N	N	N	-	-	-	-	p	p	p	p	p	p	p	p	ETB
-----	---	---	---	---	---	---	---	---	---	---	---	---	---	---	---	---	---	-----

Service functions

Mileage (kilometre) counter

It is only possible to enquire the kilometre values of printer and printhead by interface and not to set them to 0.

Enquire printer's mileage

SOH	F	C	H	A	-	-	w	p	p	p	p	p	p	p	p	ETB
-----	---	---	---	---	---	---	---	---	---	---	---	---	---	---	---	-----

Answer

SOH	A	N	N	N	N	N	N	N	N	p	p	p	p	p	p	p	ETB
-----	---	---	---	---	---	---	---	---	---	---	---	---	---	---	---	---	-----

Enquire printhead's mileage

SOH	F	C	H	B	-	-	w	p	p	p	p	p	p	p	p	ETB
-----	---	---	---	---	---	---	---	---	---	---	---	---	---	---	---	-----

Answer

SOH	A	N	N	N	N	N	N	N	N	p	p	p	p	p	p	p	ETB
-----	---	---	---	---	---	---	---	---	---	---	---	---	---	---	---	---	-----

NNNNNNNN = Indication of mileage of printer res. printhead in meters (e.g. '00000123' = 123 m)

Enquire printhead temperature

SOH	F	C	M	C	-	-	w	p	p	p	p	p	p	p	p	ETB
-----	---	---	---	---	---	---	---	---	---	---	---	---	---	---	---	-----

Answer

SOH	A	N	-	-	-	-	-	-	p	p	p	p	p	p	p	ETB
-----	---	---	---	---	---	---	---	---	---	---	---	---	---	---	---	-----

NNN: value of printhead temperature, 3 digit ASCII number in degree

Printing

Set line number of label (n digits)

SOH	F	B	A	A	-	-	r	N	ETB
-----	---	---	---	---	---	---	---	---	-----

N: Indication of line number in ASCII (1, 10, 100, ...)

Enquire line number of label

SOH	F	B	A	A	-	-	w	p	p	p	p	p	p	p	p	ETB
-----	---	---	---	---	---	---	---	---	---	---	---	---	---	---	---	-----

Answer

SOH	A	N	-	-	-	-	-	-	-	p	p	p	p	p	p	p	ETB
-----	---	---	---	---	---	---	---	---	---	---	---	---	---	---	---	---	-----

Start /Stop command

Additionally to the start / stop command it is possible to interrupt a print order via parameter / remote set.

SOH	F	D	-	-	-	-	r	N	-	-	-	-	-	-	-	ETB
-----	---	---	---	---	---	---	---	---	---	---	---	---	---	---	---	-----

N = '0' – interrupt printing

N = '1' – continue printing

N = '2' – cancel print order, when it is already stopped

Reset error

Reset error

SOH	F	C	M	H	-	-	r	N	N	N	N	-	-	-	-	ETB
-----	---	---	---	---	---	---	---	---	---	---	---	---	---	---	---	-----

NNNN = Indication of current error ID or '9999"

Enquire error

SOH	F	C	M	H	-	-	w	p	p	p	p	p	p	p	p	ETB
-----	---	---	---	---	---	---	---	---	---	---	---	---	---	---	---	-----

Answer

SOH	A	N	N	N	N	0	0	0	0	p	p	p	p	p	p	p	ETB
-----	---	---	---	---	---	---	---	---	---	---	---	---	---	---	---	---	-----

Readout error ID and error text

SOH	F	C	M	H	A	-	w	p	p	p	p	p	p	p	ETB
-----	---	---	---	---	---	---	---	---	---	---	---	---	---	---	-----

Answer

SOH	A	N	N	N	N	;	error text	;	p	p	p	p	p	p	p	p	ETB
-----	---	---	---	---	---	---	------------	---	---	---	---	---	---	---	---	---	-----

Item number of print order

By means of this command the Host computer can enquire following item numbers:

Complete number of current print order

SOH	F	B	B	A	-	-	w	p	p	p	p	p	p	p	p	ETB
-----	---	---	---	---	---	---	---	---	---	---	---	---	---	---	---	-----

Number of labels which are still to print

SOH	F	B	B	B	-	-	w	p	p	p	p	p	p	p	p	ETB
-----	---	---	---	---	---	---	---	---	---	---	---	---	---	---	---	-----

Number of labels which are already printed

SOH	F	B	B	C	-	-	w	p	p	p	p	p	p	p	p	ETB
-----	---	---	---	---	---	---	---	---	---	---	---	---	---	---	---	-----

Interval in cutter mode

SOH	F	B	B	D	-	-	w	p	p	p	p	p	p	p	p	ETB
-----	---	---	---	---	---	---	---	---	---	---	---	---	---	---	---	-----

At the end of one of these commands the printer returns the corresponding number as ASCII value (4 res. 5 digits) in the answer set.

Answer

SOH	A	N	N	N	N	-	-	-	-	p	p	p	p	p	p	p	ETB
-----	---	---	---	---	---	---	---	---	---	---	---	---	---	---	---	---	-----

With this set it is also possible to transmit the item number of print order and the interval (in cutter mode) to the printer.

Item number of print order

SOH	F	B	B	A	-	-	r	N	N	N	N	N	-	-	-	ETB
-----	---	---	---	---	---	---	---	---	---	---	---	---	---	---	---	-----

NNNNN: 5 digits item number of order

Interval in cutter mode

SOH	F	B	B	D	-	-	r	N	N	N	N	-	-	-	-	ETB
-----	---	---	---	---	---	---	---	---	---	---	---	---	---	---	---	-----

NNNNN: Interval

Start printing

SOH	F	B	C	-	-	-	r	-	-	-	-	-	-	-	-	-	ETB
-----	---	---	---	---	---	---	---	---	---	---	---	---	---	---	---	---	-----

This command starts the print order which is actually set in the printer. The current parameter such as print mode, speed, initialisation etc. are used. Therefore it is possible to print e.g. item numbers with 5 digits. However, before you have to transmit the corresponding item number with set 'FBBA'.

SOH	F	B	D	-	-	-	r	-	-	-	-	-	-	-	-	-	ETB
-----	---	---	---	---	---	---	---	---	---	---	---	---	---	---	---	---	-----

Start printing (see above) but without tear off offset.

SOH	F	B	E	-	-	-	r	n	n	n	n	n	n	n	n	n	ETB
-----	---	---	---	---	---	---	---	---	---	---	---	---	---	---	---	---	-----

Initialisation of page handling

SOH	F	B	F	-	-	-	r	ETB
-----	---	---	---	---	---	---	---	-----

Selection of current page

SOH	F	B	G	-	-	-	r	N	ETB
-----	---	---	---	---	---	---	---	---	-----

N: current page number (1...10)

Select order of pages which are to print

SOH	F	B	H	-	-	-	r	P ₁	P ₂	P ₃	ETB
-----	---	---	---	---	---	---	---	----------------	----------------	----------------	-----

P₁; P₂;...= pages which are to print

Generation of page without print start

SOH	F	B	I	-	-	-	r	S	ETB
-----	---	---	---	---	---	---	---	---	-----

With this command the corresponding page is only generated, i.e. no print start signal is sent.

S = 1: sorted (printed are e.g. pages 1-5, then again 1-5 etc.)

S = x: unsorted (printed are x times page 1, then x times page 2, etc.)

Feed

Release a label feed

SOH	F	E	-	-	-	-	r	-	-	-	-	-	-	-	-	-	ETB
-----	---	---	---	---	---	---	---	---	---	---	---	---	---	---	---	---	-----

Test print

Release a test print

SOH	F	F	-	-	-	-	r	-	-	-	-	-	-	-	-	-	ETB
-----	---	---	---	---	---	---	---	---	---	---	---	---	---	---	---	---	-----

Status print

Parameter set in order to print status report

SOH	F	C	M	Q	-	-	r	N	-	-	-	-	-	-	-	-	ETB
-----	---	---	---	---	---	---	---	---	---	---	---	---	---	---	---	---	-----

N = 0: Printer settings

N = 1: Bar codes

N = 2: Fonts

Cancel print orders

Cancel all active print orders

SOH	F	G	A	-	-	-	r	N	-	-	-	-	-	-	-	-	ETB
-----	---	---	---	---	---	---	---	---	---	---	---	---	---	---	---	---	-----

N = -: Cancel active print orders and delete all label data

N = 1: Cancel active print orders and receive label data

With the execution of this command:

- possible upcoming errors are confirmed
- possible upcoming customised entries are cancelled

Remote console

Set port

SOH	F	C	R	A	-	-	r	N	-	-	-	-	-	-	-	-	ETB
-----	---	---	---	---	---	---	---	---	---	---	---	---	---	---	---	---	-----

N = 0 – Off

N = 1 – COM1

N = 2 – Ethernet

Enquire port

SOH	F	C	R	A	-	-	w	p	p	p	p	p	p	p	p	p	ETB
-----	---	---	---	---	---	---	---	---	---	---	---	---	---	---	---	---	-----

Answer

SOH	A	N	-	-	-	-	-	-	-	p	p	p	p	p	p	p	ETB
-----	---	---	---	---	---	---	---	---	---	---	---	---	---	---	---	---	-----

PARAMETER SETS FOR OPTIONS

Network

Sets for option Ethernet

General

Example:

SOH	F	C	L	A	-	-	r	C	0	A	8	0	0	1	5	ETB
-----	---	---	---	---	---	---	---	---	---	---	---	---	---	---	---	-----

All network parameter sets start in the third column with a 'L'. Column 4 shows the identification for the corresponding network parameter. Column 5 can show another sub-identification.

Because of the fact that the argument size is limited to 8 characters, the IP addresses (IP address, network mask, gateway address) which consist of 32 bit are transmitted in HEX presentation. For all data which is transmitted in HEX presentation (also the MAC address) it is allowed to use capital as well as small letters.

In contrary to the parameter settings of the other interfaces, the settings of the following sets were saved immediately onto Flash, i.e. it is not necessary to save the currently set configuration before switching off the printer so the modifications are still available after switching on.

So that the made modifications become active, also without printer Reset it is necessary to transmit a corresponding Z set which effects a Reset of the network devices.

Set IP address (e.g. 192.168.0.21)

SOH	F	C	L	A	-	-	r	C	0	A	8	0	0	1	5	ETB
-----	---	---	---	---	---	---	---	---	---	---	---	---	---	---	---	-----

Enquire IP address

SOH	F	C	L	A	-	-	w	C	0	A	8	0	0	1	5	ETB
-----	---	---	---	---	---	---	---	---	---	---	---	---	---	---	---	-----

Answer

SOH	A	C	0	A	8	0	0	1	5	p	p	p	p	p	p	p	ETB
-----	---	---	---	---	---	---	---	---	---	---	---	---	---	---	---	---	-----

Set netmask (e.g. 255.255.255.0)

SOH	F	C	L	B	-	-	r	F	F	F	F	F	F	0	0	ETB
-----	---	---	---	---	---	---	---	---	---	---	---	---	---	---	---	-----

Enquire netmask

SOH	F	C	L	B	-	-	w	F	F	F	F	F	F	0	0	ETB
-----	---	---	---	---	---	---	---	---	---	---	---	---	---	---	---	-----

Answer

SOH	A	F	F	F	F	F	F	0	0	p	p	p	p	p	p	p	ETB
-----	---	---	---	---	---	---	---	---	---	---	---	---	---	---	---	---	-----

Set Gateway address (e.g. 192.168.0.1)

SOH	F	C	L	C	-	-	r	C	0	A	8	0	0	0	1	ETB
-----	---	---	---	---	---	---	---	---	---	---	---	---	---	---	---	-----

Enquire Gateway address

SOH	F	C	L	C	-	-	w	C	0	A	8	0	0	0	1	ETB
-----	---	---	---	---	---	---	---	---	---	---	---	---	---	---	---	-----

Answer

SOH	A	C	0	A	8	0	0	0	1	p	p	p	p	p	p	p	p	ETB
-----	---	---	---	---	---	---	---	---	---	---	---	---	---	---	---	---	---	-----

Set transmission mode (e.g. auto recognition)

SOH	F	C	L	D	-	-	r	0	-	-	-	-	-	-	-	-	ETB
-----	---	---	---	---	---	---	---	---	---	---	---	---	---	---	---	---	-----

0 = auto recognition

1 = 10 MBit/s half duplex

2 = 10 MBit/s full duplex

3 = 100 MBit/s half duplex

4 = 100 MBit/s full duplex

Enquire transmission mode

SOH	F	C	L	D	-	-	w	0	-	-	-	-	-	-	-	-	ETB
-----	---	---	---	---	---	---	---	---	---	---	---	---	---	---	---	---	-----

Answer

SOH	A	0	-	-	-	-	-	-	-	p	p	p	p	p	p	p	p	ETB
-----	---	---	---	---	---	---	---	---	---	---	---	---	---	---	---	---	---	-----

Set support DHCP

SOH	F	C	L	E	-	-	r	N	ETB
-----	---	---	---	---	---	---	---	---	-----

N: 0 = Off

1 = On

Enquire support DHCP

SOH	F	C	L	E	-	-	w	p	p	p	p	p	p	p	p	p	ETB
-----	---	---	---	---	---	---	---	---	---	---	---	---	---	---	---	---	-----

Answer

SOH	A	N	-	-	-	-	-	-	-	p	p	p	p	p	p	p	p	ETB
-----	---	---	---	---	---	---	---	---	---	---	---	---	---	---	---	---	---	-----

Set MAC address (e.g. 00-07-4A-43-19-08)

SOH	F	C	L	M	B	-	r	0	0	0	7	4	A	-	-	ETB
-----	---	---	---	---	---	---	---	---	---	---	---	---	---	---	---	-----

SOH	F	C	L	M	A	-	r	4	3	1	9	0	8	-	-	ETB
-----	---	---	---	---	---	---	---	---	---	---	---	---	---	---	---	-----

A MAC address has a width of 48 bit and is normally indicated in hexadecimals.

With a B record it is possible to modify our identification of the MAC address. All our machines start with 00-07-4A as default. This corresponds to the Memory-Pool which the MAC address committee assigned to us to guarantee that the MAC address is world-wide manufacturer-spreading unique.

With the A record it is possible to set any address in our pool.

Enquire MAC address

SOH	F	C	L	M	B	-	w	0	0	0	7	4	A	-	-	ETB
-----	---	---	---	---	---	---	---	---	---	---	---	---	---	---	---	-----

SOH	F	C	L	M	A	-	w	4	3	1	9	0	8	-	-	ETB
-----	---	---	---	---	---	---	---	---	---	---	---	---	---	---	---	-----

Answer

SOH	A	0	0	0	7	4	A	-	-	p	p	p	p	p	p	p	ETB
-----	---	---	---	---	---	---	---	---	---	---	---	---	---	---	---	---	-----

SOH	A	4	3	1	9	0	8	-	-	p	p	p	p	p	p	p	ETB
-----	---	---	---	---	---	---	---	---	---	---	---	---	---	---	---	---	-----

Reset network device

SOH	F	C	L	Z	-	-	r	-----	ETB
-----	---	---	---	---	---	---	---	-------	-----

For this set is no enquiry possible. This set causes that modifications made by the transfer of the previous sets become effective.

Assign printer name

SOH	F	C	L	F	-	-	r	N	N	N	N	N	N	N	N	N	ETB
-----	---	---	---	---	---	---	---	---	---	---	---	---	---	---	---	---	-----

N: printer name is allowed to exist of max. 11 characters (A...Z, a...z, 0...9, -,)

Enquire printer name

SOH	F	C	L	F	-	-	w	p	p	p	p	p	p	p	ETB
-----	---	---	---	---	---	---	---	---	---	---	---	---	---	---	-----

Answer

SOH	A	N	N	N	N	N	N	N	;	p	p	p	p	p	p	p	ETB
-----	---	---	---	---	---	---	---	---	---	---	---	---	---	---	---	---	-----

Cutter

Set cutter mode

SOH	F	C	D	D	-	-	r	N	-	-	-	-	-	-	-	-	ETB
-----	---	---	---	---	---	---	---	---	---	---	---	---	---	---	---	---	-----

N = 0 – cutter mode Off

N = 1 – single cut

N = 2 – mode 1 (w/o cutter offset), print no. of pieces w. cut after each label w/o backfeed

N = 3 – mode 2 (w backfeed), print no. of pieces w. cut after each label w. backfeed

N = 4 – interval cut with final cut, transmit interval with later

N = 5 – interval cut without final cut, transmit interval width later

N = 6 – final cutt (cut after print end)

Enquire cutter mode

SOH	F	C	D	D	-	-	w	p	p	p	p	p	p	p	p	p	ETB
-----	---	---	---	---	---	---	---	---	---	---	---	---	---	---	---	---	-----

Answer

SOH	A	N	-	-	-	-	-	-	-	p	p	p	p	p	p	p	p	ETB
-----	---	---	---	---	---	---	---	---	---	---	---	---	---	---	---	---	---	-----

Set cutter offset

SOH	F	C	S	C	A	-	r	V	N	N	N	-	-	-	-	ETB
-----	---	---	---	---	---	---	---	---	---	---	---	---	---	---	---	-----

V: pre-sign of offset (always +)

NNN: offset value, 3 digit ASCII number in 1/10 mm

Enquire cutter offset

SOH	F	C	S	C	A	-	w	p	p	p	p	p	p	p	p	p	ETB
-----	---	---	---	---	---	---	---	---	---	---	---	---	---	---	---	---	-----

Answer

SOH	A	V	N	N	N	-	-	-	-	p	p	p	p	p	p	p	-	ETB
-----	---	---	---	---	---	---	---	---	---	---	---	---	---	---	---	---	---	-----

Dispenser

Set dispenser mode

SOH	F	C	D	C	-	-	r	N	-	-	-	-	-	-	-	-	ETB
-----	---	---	---	---	---	---	---	---	---	---	---	---	---	---	---	---	-----

N = 0 – dispenser mode Off

N = 2 – dispenser photocell

N = 4 – dispenser photocell continuous

Enquire dispenser mode

SOH	F	C	D	C	-	-	w	p	p	p	p	p	p	p	p	p	ETB
-----	---	---	---	---	---	---	---	---	---	---	---	---	---	---	---	---	-----

Answer

SOH	A	N	-	-	-	-	-	-	-	p	p	p	p	p	p	p	ETB
-----	---	---	---	---	---	---	---	---	---	---	---	---	---	---	---	---	-----

Set dispenser offset*

SOH	F	C	S	D	A	-	r	V	N	N	N	-	-	-	-	ETB
-----	---	---	---	---	---	---	---	---	---	---	---	---	---	---	---	-----

V: pre-sign of offset (always +)

NNN: offset value, 3 digit ASCII number in 1/10 mm

Enquire dispenser offset

SOH	F	C	S	D	A	-	w	p	p	p	p	p	p	p	p	p	ETB
-----	---	---	---	---	---	---	---	---	---	---	---	---	---	---	---	---	-----

Answer

SOH	A	V	N	N	N	-	-	-	-	p	p	p	p	p	p	p	ETB
-----	---	---	---	---	---	---	---	---	---	---	---	---	---	---	---	---	-----

Dispensing photocell

Enquire current value at dispensing photocell

SOH	F	C	M	B	E	-	w	p	p	p	p	p	p	p	p	p	ETB
-----	---	---	---	---	---	---	---	---	---	---	---	---	---	---	---	---	-----

Answer

SOH	A	N	N	N	-	-	-	-	-	p	p	p	p	p	p	p	ETB
-----	---	---	---	---	---	---	---	---	---	---	---	---	---	---	---	---	-----

NNN: value of dispensing photocell, 3 digit ASCII number in 1/100 V

Enquire condition of dispensing photocell

SOH	F	C	M	B	E	A	w	p	p	p	p	p	p	p	p	p	ETB
-----	---	---	---	---	---	---	---	---	---	---	---	---	---	---	---	---	-----

Answer

SOH	A	N	-	-	-	-	-	-	-	p	p	p	p	p	p	p	ETB
-----	---	---	---	---	---	---	---	---	---	---	---	---	---	---	---	---	-----

N = 0 – no label is at photocell

N = 1 – label is at photocell

The set switching threshold of dispensing photocell is taken into consideration.

Date and time

Set date

SOH	F	C	I	A	-	-	r	D	D	M	O	Y	Y	D	W	ETB
-----	---	---	---	---	---	---	---	---	---	---	---	---	---	---	---	-----

DD = day of month

MO = month

YY = year

DW = day of week ('00' = Sunday)

Enquire date

SOH	F	C	I	A	-	-	w	p	p	p	p	p	p	p	p	ETB
-----	---	---	---	---	---	---	---	---	---	---	---	---	---	---	---	-----

Answer

SOH	A	D	D	M	O	Y	Y	D	W	p	p	p	p	p	p	p	ETB
-----	---	---	---	---	---	---	---	---	---	---	---	---	---	---	---	---	-----

Set time

SOH	F	C	I	B	-	-	r	H	H	M	I	S	S	A	M	ETB
-----	---	---	---	---	---	---	---	---	---	---	---	---	---	---	---	-----

HH = hours

MI = minutes

SS = seconds

AM = mode ('am' = 12 hours mode AM, 'pm' = 12 hours mode PM, '—' = 24 hours mode)

Enquire time

SOH	F	C	I	B	-	-	w	p	p	p	p	p	p	p	p	ETB
-----	---	---	---	---	---	---	---	---	---	---	---	---	---	---	---	-----

Answer

SOH	A	H	H	M	I	S	S	A	M	p	p	p	p	p	p	p	ETB
-----	---	---	---	---	---	---	---	---	---	---	---	---	---	---	---	---	-----

Automatically adjust clock for daylight saving changes

Because of the fact that there is no world-wide regulation if and when a changing of time between summer and wintertime (normal time) in the individual countries takes place, we distinguish between the following four formats for the definition for beginning and end of summertime.

F 0:	european format start of summertime = last Sunday in March end of summertime = last Sunday in October W: week (1 = first, ..., 5 = last) WD: day of week (0 = Sunday, ..., 6 = Saturday) MM: month (01 = January, ..., 12 = December)
F 1:	fix date with indication of year DD: day MM: month (01 = January, ..., 12 = December) YY: year
F 2:	fix date without indication of year DD: day MM: month (01 = January, ..., 12 = December)
F 3:	week day after day in month WD: day of week (0 = Sunday, ..., 6 = Saturday) DD: after day (only the first day is taken into consideration) MM: month (01 = January, ..., 12 = December)

Set automatically adjust clock for daylight saving changes

SOH	F	C	I	G	-	-	r	N	-	-	-	-	-	-	-	-	ETB
-----	---	---	---	---	---	---	---	---	---	---	---	---	---	---	---	---	-----

Enquire automatically adjust clock for daylight saving changes

SOH	F	C	I	G	-	-	w	p	p	p	p	p	p	p	p	p	ETB
-----	---	---	---	---	---	---	---	---	---	---	---	---	---	---	---	---	-----

Answer

SOH	A	N	-	-	-	-	-	-	-	p	p	p	p	p	p	p	ETB
-----	---	---	---	---	---	---	---	---	---	---	---	---	---	---	---	---	-----

N = 0 – Automatically adjust clock for daylight saving changes Off

N = 1 – Automatically adjust clock for daylight saving changes On

Set beginning of summertime

F 0: SOH F C I H - - r F W ; WD ; M M ; H H ; M M ETB

F 1: SOH F C I H - - r F D D ; M M ; Y Y ; H H ; M M ETB

F 2: SOH F C I H - - r F D D ; M M ; H H ; M M ETB

F 3: SOH F C I H - - r F WD ; D D ; M M ; H H ; M M ETB

Enquire beginning of summertime

SOH F C I H - - w p p p p p p p p ETB

Answer

SOH A F W W D M M p p p p p p p p ETB

The answer depends on each set format.

Set end of summertime

F 0: SOH F C I I - - r F W ; WD ; M M ; H H ; M M ETB

F 1: SOH F C I I - - r F D D ; M M ; Y Y ; H H ; M M ETB

F 2: SOH F C I I - - r F D D ; M M ; H H ; M M ETB

F 3: SOH F C I I - - r F WD ; D D ; M M ; H H ; M M ETB

Enquire end of summertime

SOH F C I I - - w p p p p p p p p ETB

Answer

SOH A F W W D M M p p p p p p p p ETB

The answer depends on each set format.

Set time shifting

SOH F C I J - - r N N N - - - - - ETB

NNN = minutes

Enquire time shifting

SOH F C I J - - w p p p p p p p p ETB

Answer

SOH A N N N p p p p p p p p ETB

Save configuration permanent

In case you want to save the described settings permanent into the printer, then you have to transmit the following command to the printer.

SOH	F	X	-	-	-	-	r	N	-	-	-	-	-	-	-	-	ETB
N: 0 = save current parameter																	
1 = set all parameters to default values																	

Readout configuration

SOH	F	X	-	-	-	-	w	-	-	-	-	-	-	-	-	-	ETB
-----	---	---	---	---	---	---	---	---	---	---	---	---	---	---	---	---	-----

The printer sends as answer all current settings as parameter sets.

Status enquiry

Host computer can receive information about the printer by the serial interface. The status enquiry has the following data format:

SOH	S	ETB	S = ASCIIs
-----	---	-----	------------

Status return information:

After receiving the status enquiry the printer sends the corresponding status return information.

Data format of status enquiry

SOH	1. Byte							2. Byte							5. - 1. digit	ETB	
	8	7	6	5	4	3	2	1	8	7	6	5	4	3	2	1	

1. Byte	=	1. status byte
		8. Bit = free
		7. Bit = always set
		6. Bit = free
		5. Bit = 1 – active print order 0 – no. of pieces = 0 (no print order)
		4. Bit = 1 – stop key activated 0 – stop key not activated
		3. Bit = cutter error 0 – no error; 1 – error
		2. Bit = labels 0 – no error; 1 – error
		1. Bit = transfer ribbon 0 – no error; 1 – error
2. Byte	=	2. status byte
		8. Bit = free
		7. Bit = free
		6. Bit = free
		5. Bit = free
		4. Bit = free
		3. Bit = memory card
		2. Bit = mask set
		1. Bit = printhead temperature
5.-1. position	=	number of pieces with 5 digits as ASCII characters min. '00000' / max. '65535'

AUTOSTATUS

The printers are equipped with an auto status function, i.e. in certain operating modes the printer actively sends the corresponding status. This can be enquired by the serial interface.

To activate the auto status, the host computer has to send the following command to the printer:

SOH	G	1. Byte	2. Byte	ETB
-----	---	---------	---------	-----

Each of the below indicated message which is observed and send by the printer has to be transmitted with a set Bit (see table below 1. Byte and 2. Byte) to the printer via the auto state function. The printer sends after each performed condition the corresponding message (answer) to the host computer.

The following messages are provided:

- 1 Start of generation**
- 2 End of generation**
The printer sends this state in case data for a complete label was generated. The test print was not taken into consideration.
For counters/date variables the printer sends for each label a status cycle (start, end).
- 3 Start of printing**
- 4 End of printing**
The start of the print is send in case the generated data is send.
The end of the print is send in case the print of the label is finished and the motor has stopped.
- 5 Start of cutting**
- 6 End of cutting**
This status describes the cutting. Here it is possible to check the end of the cutting at timeout
→ error.
- 7 Start of feeding**
- 8 End of feeding**
This status is send in case an additional feeding (dispenser, cutter, tear off) is released.
- 9 Start of a print order**
- 10 End of print order**
This status signalises the start and end of a complete print order (1...99999 labels). This status is active in all operating modes.
- 11 Error**
This status message is send in case an error occurs.
- 12 Printing stopped**
This message is send if the printing is stopped.
- 13 Printing resumed**
This message is send if the printing is resumed.

The printer sends the auto status in the following format to the host computer:

SOH	G	1. Byte	2. Byte	ETB
-----	---	---------	---------	-----

1. Byte

8. Bit	7. Bit	6. Bit	5. Bit	4. Bit	3. Bit	2. Bit	1. Bit
start generating	end generating	start printing	end printing	start cutting	end cutting	start feeding	always 0

2. Byte

8. Bit	7. Bit	6. Bit	5. Bit	4. Bit	3. Bit	2. Bit	1. Bit
end feeding	start print order	end print order	error	free	printing stopped	printing resumed	always 0

Attention: Bit 1 has to be in 1. Byte and 2. Byte always 0, otherwise the printer possibly could recognise SOH or ETB.

At the status message of the printer to the host computer always at least 1 Bit is set. However, it could be occur that several Bits are set at the same time.

At the status demand of the host computer to the printer it is also possible that several Bits are set at the same time.

The auto status demand is saved in the printer, i.e. it is set to 0 after switching off/on. Therefore it is necessary to demand it anew after each time the printer is switched on.

Example:

The printer should observe the start of a print order. For this the host computer sends the following demand to the printer.

SOH	G	00000000	01000000	ETB
-----	---	----------	----------	-----

After the condition is fulfilled (= start of the print order) the printer sends the following message to the host computer:

SOH	G	00000000	01000000	ETB
-----	---	----------	----------	-----

With regard to the contents the answer corresponds always to the format set.

CHARACTER SETS

Bitmap fonts													
ID	01	02	03	04	05	06	07	21	22	23	24	28	29
	0,8x1,1mm	1,2x1,7mm	1,8x2,6mm	4,0x5,6mm	1,8x3,2mm	1,5x2,9mm	1,2x2,2mm	1,0; 13	1,8; 21	2,6; 31	5,6; 67	4,0; 48	0,8; 9
GEM Germn	2)	2)	2)	2)	2)	2)	2)	2)	2)	2)	2)	2)	2)
GEM English	2)	2)	2)	2)	2)	2)	2)	2)	2)	2)	2)	2)	2)
GEM French	2)	2)	2)	2)	2)	2)	2)	2)	2)	2)	2)	2)	2)
GEM Swedish	2)	2)	2)	2)	2)	2)	2)	2)	2)	2)	2)	2)	2)
GEM Danish	2)	2)	2)	2)	2)	2)	2)	2)	2)	2)	2)	2)	2)
CP 437 (German)	2)	2)	2)	2)	2)	2)	2)	2)	2)	2)	2)	2)	2)
CP 850 (multilingual West European)	2)	2)	2)	2)	2)	2)	2)	2)	2)	2)	2)	2)	2)
CP 852 (multilingual East European)	5)	5)	5)	5)	5)	5)	5)	5)	5)	5)	5)	5)	5)
CP1250 (Latin 2; Central European)	3)	3)	3)	3)	3)	3)	3)	3)	3)	3)	3)	3)	3)
CP1251 (Cyrillic)	6)	6)	6)	6)	6)	6)	6)	6)	6)	6)	6)	6)	6)
CP1252 ANSI (Latin 1, West European)	2)	2)	2)	2)	2)	2)	2)	2)	2)	2)	2)	2)	2)
CP1253 (Greek)	6)	6)	6)	6)	6)	6)	6)	6)	6)	6)	6)	6)	6)
CP1254 (Latin 5, Turkish)	6)	6)	6)	6)	6)	6)	6)	6)	6)	6)	6)	6)	6)
CP 1257 (Baltic)	6)	6)	6)	6)	6)	6)	6)	6)	6)	6)	6)	6)	6)
	1) descenders	2) standard	3) at the moment not available, can be replaced by vector fonts (ID3; ID11)	4) on demand, beginning with version 1.41a	5) on demand, only 200 dpi printers	6) not available							

Beginning with version 1.41a different character sets were offered but as default the printers are equipped with Latin 1.

Following languages are supported:

Afrikaans	English	Italian	Serbian
Albanian	Estonian	Latvian	Slovak
Basque	Faeroese	Lithuanian	Slovenian
Belarusian	Finnish	Macedonian (FYROM)	Spanish
Bulgarian	French	Norwegian (Bokmal)	Swahili
Catalan	German	Norwegian (Nynorsk)	Swedish
Croatian	Greek (modern, monotonic)	Polish	Turkish
Czech	Hungarian	Portuguese	Ukrainian
Danish	Icelandic	Romanian	
Dutch	Indonesian	Russian	

Outline of the most important character sets for Central and East European languages

Codepage	Unterstützte Sprachen
1251 (Cyrillic)	Russian, Bearusian, Serbian, Bulgarian, Ukrainian, Macedonian
1250 (Latin 2, Central European)	Romanian, Slovak, Hungarian, Slovenian, Croatian, Serbian, Polish, Czech
852 (multilingual, Eas European)	Polish, Czech, Romanian, Slovak, Hungarian, Slovenian, Croatian, Serbian
1257 (Baltic)	Estonian, Latvian, Lithuanian

International ANSI character font

ANSI	Dec.	HEX	ANSI	Dec.	HEX	ANSI	Dec.	HEX	ANSI	Dec.	HEX	ANSI	Dec.	HEX
SP	32	20	Q	81	51	,	130	82	³	179	B3	ä	228	E4
!	33	21	R	82	52	f	131	83	´	180	B4	å	229	E5
"	34	22	S	83	53	”	132	84	µ	181	B5	æ	230	E6
#	35	23	T	84	54	…	133	85	¶	182	B6	ç	231	E7
\$	36	24	U	85	55	†	134	86	·	183	B7	è	232	E8
%	37	25	V	86	56	‡	135	87	ˆ	184	B8	é	233	E9
&	38	26	W	87	57	‰	136	88	˘	185	B9	ê	234	EA
'	39	27	X	88	58	‰	137	89	°	186	BA	ë	235	EB
(40	28	Y	89	59	Š	138	8A	»	187	BB	ì	236	EC
)	41	29	Z	90	5A	‹	139	8B	¼	188	BC	í	237	ED
*	42	2A	[91	5B	Œ	140	8C	½	189	BD	î	238	EE
+	43	2B	\	92	5C	Ž	141	8D	¾	190	BE	ï	239	EF
,	44	2C]	93	5D	ž	142	8E	¿	191	BF	ð	240	F0
-	45	2D	^	94	5E	Ž	143	8F	À	192	C0	ñ	241	F1
.	46	2E	_	95	5F	ˆ	144	90	Á	193	C1	ò	242	F2
/	47	2F	˘	96	60	‘	145	91	Â	194	C2	ó	243	F3
0	48	30	a	97	61	’	146	92	Ã	195	C3	ô	244	F4
1	49	31	b	98	62	“	147	93	Ä	196	C4	õ	245	F5
2	50	32	c	99	63	”	148	94	Å	197	C5	ö	246	F6
3	51	33	d	100	64	•	149	95	Æ	198	C6	÷	247	F7
4	52	34	e	101	65	—	150	96	Ç	199	C7	ø	248	F8
5	53	35	f	102	66	—	151	97	È	200	C8	ù	249	F9
6	54	36	g	103	67	™	152	98	É	201	C9	ú	250	FA
7	55	37	h	104	68	™	153	99	Ê	202	CA	û	251	FB
8	56	38	i	105	69	š	154	9A	Ë	203	CB	ü	252	FC
9	57	39	j	106	6A	›	155	9B	Ì	204	CC	ý	253	FD
:	58	3A	k	107	6B	œ	156	9C	Í	205	CD	þ	254	FE
;	59	3B	l	108	6C	œ	157	9D	Î	206	CE	ÿ	255	FF
<	60	3C	m	109	6D	ž	158	9E	Ï	207	CF			
=	61	3D	n	110	6E	Ÿ	159	9F	Ð	208	D0			
>	62	3E	o	111	6F	Ÿ	160	A0	Ñ	209	D1			
?	63	3F	p	112	70	ı	161	A1	Ò	210	D2			
@	64	40	q	113	71	ϕ	162	A2	Ó	211	D3			
A	65	41	r	114	72	£	163	A3	Ô	212	D4			
B	66	42	s	115	73	¤	164	A4	Õ	213	D5			
C	67	43	t	116	74	¥	165	A5	Ö	214	D6			
D	68	44	u	117	75	¦	166	A6	×	215	D7			
E	69	45	v	118	76	§	167	A7	Ø	216	D8			
F	70	46	w	119	77	¨	168	A8	Ù	217	D9			
G	71	47	x	120	78	©	169	A9	Ú	218	DA			
H	72	48	y	121	79	ª	170	AA	Û	219	DB			
I	73	49	z	122	7A	«	171	AB	Ü	220	DC			
J	74	4A	{	123	7B	¬	172	AC	Ý	221	DD			
K	75	4B		124	7C	-	173	AD	Þ	222	DE			
L	76	4C	}	125	7D	®	174	AE	ß	223	DF			
M	77	4D	~	126	7E	™	175	AF	à	224	E0			
N	78	4E		127	7F	°	176	B0	á	225	E1			
O	79	4F	€	128	80	±	177	B1	â	226	E2			
P	80	50		129	81	²	178	B2	ã	227	E3			

Codepage 437

Dec.	Dec.	Dec.	Dec.	Dec.				
32		81	Q	130	é	179		228
33	!	82	R	131	â	180		229
34	'	83	S	132	à	181		230
35	#	84	T	133	à	182		231
36	\$	85	U	134	â	183		232
37	%	86	V	135	ç	184		233
38	&	87	W	136	ê	185		234
39	'	88	X	137	ë	186		235
40	(89	Y	138	è	187		236
41)	90	Z	139	ï	188		237
42	*	91	[140	î	189		238
43	+	92	\	141	ì	190		239
44	,	93]	142	Ä	191		240
45	-	94	^	143	Å	192		241
46	.	95	~	144	É	193		242
47	/	96	¯	145	æ	194		243
48	0	97	a	146	Æ	195		244
49	1	98	b	147	ô	196		245
50	2	99	c	148	ö	197		246
51	3	100	d	149	ò	198		247
52	4	101	e	150	û	199		248
53	5	102	f	151	ù	200		249
54	6	103	g	152	ÿ	201		250
55	7	104	h	153	Ö	202		251
56	8	105	i	154	Ü	203		252
57	9	106	j	155	φ	204		253
58	:	107	k	156	£	205		254
59	;	108	l	157	¥	206		255
60	<	109	m	158		207		
61	=	110	n	159		208		
62	>	111	o	160	á	209		
63	?	112	p	161	í	210		
64	@	113	q	162	ó	211		
65	A	114	r	163	ú	212		
66	B	115	s	164	ñ	213	€	
67	C	116	t	165	Ñ	214		
68	D	117	u	166		215		
69	E	118	v	167	°	216		
70	F	119	w	168		217		
71	G	120	x	169		218		
72	H	121	y	170		219		
73	I	122	z	171	½	220		
74	J	123	{	172	¼	221		
75	K	124	!	173		222		
76	L	125	}	174	«	223		
77	M	126	~	175	»	224		
78	N	127		176		225	ß	
79	O	128	Ç	177		226		
80	P	129	ü	178		227		

Codepage 850

Dec.	Dec.	Dec.	Dec.	Dec.					
32		81	Q	130	é	179		228	ö
33	!	82	R	131	â	180	Á	229	Õ
34	'	83	S	132	à	181	Â	230	μ
35	#	84	T	133	à	182	À	231	
36	\$	85	U	134	å	183	©	232	
37	%	86	V	135	ç	184		233	Ú
38	&	87	W	136	ê	185		234	Û
39	'	88	X	137	ë	186		235	Ü
40	(89	Y	138	è	187		236	
41)	90	Z	139	ï	188	¢	237	
42	*	91	[140	î	189	¥	238	
43	+	92	\	141	ì	190		239	
44	,	93]	142	Ä	191		240	
45	-	94	^	143	Å	192		241	
46	.	95	¯	144	É	193		242	
47	/	96	˘	145	æ	194		243	¾
48	0	97	a	146	Æ	195		244	¶
49	1	98	b	147	ô	196		245	§
50	2	99	c	148	ö	197		246	
51	3	100	d	149	ò	198	ã	247	
52	4	101	e	150	û	199	Ä	248	°
53	5	102	f	151	ù	200		249	
54	6	103	g	152	ÿ	201		250	
55	7	104	h	153	Ö	202		251	
56	8	105	i	154	Ü	203		252	
57	9	106	j	155	ø	204		253	
58	:	107	k	156	£	205		254	
59	:	108	l	157	Ø	206		255	
60	<	109	m	158		207			
61	=	110	n	159		208			
62	>	111	o	160	á	209			
63	?	112	p	161	í	210	Ê		
64	@	113	q	162	ó	211	Ë		
65	A	114	r	163	ú	212	È		
66	B	115	s	164	ñ	213			
67	C	116	t	165	Ñ	214	Í		
68	D	117	u	166		215	Î		
69	E	118	v	167	°	216	Ï		
70	F	119	w	168		217			
71	G	120	x	169	®	218			
72	H	121	y	170		219			
73	I	122	z	171	½	220			
74	J	123	{	172	¼	221			
75	K	124		173		222	Ì		
76	L	125	}	174	«	223			
77	M	126	~	175	»	224	Ó		
78	N	127		176		225	ß		
79	O	128	Ç	177		226	Ò		
80	P	129	ü	178		227	Ö		

Codepage 852*

Dec.	Dec.	Dec.	Dec.	Dec.	
32		81 Q	130 é	179	228 ħ
33 !		82 R	131 â	180	229 ñ
34 '		83 S	132 ä	181 Á	230 Š
35 #		84 T	133 ù	182 Â	231 š
36 \$		85 U	134 ć	183 Ě	232 Ř
37 %		86 V	135 ç	184 Š	233 Ú
38 &		87 W	136 ł	185	234 ŕ
39 ' (grave)		88 X	137 ë	186	235 Ů
40 (89 Y	138 Ö	187	236 ý
41)		90 Z	139 õ	188	237 Ÿ
42 *		91 [140 î	189 Ž	238 ŧ
43 +		92 \	141 ě	190 ž	239 ' (acute)
44 ,		93]	142 Ā	191	240 - (dash)
45 -		94 ^	143 Ć	192	241 ' (grave)
46 .		95 _	144 Ę	193	242
47 /		96 `	145 Ĺ	194	243 - (hyphen)
48 0		97 a	146 Í	195	244 - (dash)
49 1		98 b	147 ô	196	245 §
50 2		99 c	148 ö	197	246 ÷
51 3		100 d	149 Ł	198 Ą	247 °
52 4		101 e	150 ł	199 ą	248 ° (circ)
53 5		102 f	151 Ś	200	249 " (quotation)
54 6		103 g	152 ś	201	250 · (bullet)
55 7		104 h	153 Ő	202	251 ũ
56 8		105 i	154 Ű	203	252 Ŕ
57 9		106 j	155 Ť	204	253 ř
58 :		107 k	156 t	205	254
59 ;		108 l	157 Ł	206	255
60 <		109 m	158 x	207	
61 =		110 n	159 č	208 đ	
62 >		111 o	160 á	209 Đ	
63 ?		112 p	161 í	210 Ď	
64 @		113 q	162 ó	211 Ě	
65 A		114 r	163 ú	212 ě	
66 B		115 s	164 Ŧ	213 Ň	
67 C		116 t	165 ž	214 í (acute)	
68 D		117 u	166 Ž	215 î	
69 E		118 v	167 ž	216 ě	
70 F		119 w	168 Ě	217	
71 G		120 x	169 ě	218	
72 H		121 y	170	219	
73 I		122 z	171 ž	220	
74 J		123 {	172 Ć	221 T	
75 K		124 128	173 §	222 U	
76 L		125 129	174 «	223	
77 M		126 ~	175 »	224 Ó	
78 N		127 Δ	176	225 ß	
79 O		128 Ç	177	226 Ñ	
80 P		129 Ů	178	227 Ñ	

* Option

Codepage 857*

Dec.	Dec.	Dec.	Dec.	Dec.		
32		130	é	179		
33	!	131	â	180		
34	'	132	à	181	Á	
35	#	133	à	182	Ă	
36	\$	134	â	183	À	
37	%	135	ç	184	©	
38	&	136	è	185		
39	'	137	ë	186		
40	(138	è	187		
41)	139	ï	188		
42	*	140	î	189	¢	
43	+	141	ı	190	¥	
44	,	142	Ä	191		
45	-	143	Å	192		
46	.	144	É	193		
47	/	145	æ	194		
48	0	146	Æ	195		
49	1	147	ô	196		
50	2	148	ö	197		
51	3	149	ò	198	ã	
52	4	150	û	199	Ä	
53	5	151	ù	200		
54	6	152	İ	201		
55	7	153	Ö	202		
56	8	154	Ü	203		
57	9	155	ø	204		
58	:	156	£	205		
59	;	157	Ø	206		
60	<	158	Ş	207		
61	=	159	ş	208	°	
62	>	160	á	209	ª	
63	?	161	í	210	Ê	
64	@	162	ó	211	Ë	
65	A	163	ú	212	È	
66	B	164	ñ	213	Ñ	
67	C	165	Ñ	214	í	
68	D	166	Ğ	215	î	
69	E	167	ğ	216	ï	
70	F	168	ı	217		
71	G	169	®	218		
72	H	170		219		
73	I	171	½	220		
74	J	172	¼	221		
75	K	173	ı	222		
76	L	174	«	223		
77	M	175	»	224	Ó	
78	N	176		225	ß	
79	O	177		226	Ò	
80	P	178		227	Ö	
					228	ö
					229	Õ
					230	µ
					231	µ
					232	µ
					233	µ
					234	Û
					235	Û
					236	ı
					237	ÿ
					238	
					239	'
					240	-
					241	±
					242	
					243	¼
					244	¶
					245	§
					246	÷
					247	˙
					248	˚
					249	˚
					250	˚
					251	˚
					252	˚
					253	˚
					254	˚
					255	˚

* Option

GEM German

Dec.	Dec.	Dec.	Dec.	Dec.					
32		81	Q	130	é	179	¢	228	€
33	!	82	R	131	â	180	œ	229	
34	'	83	S	132	à	181	Œ	230	μ
35	#	84	T	133	à	182	À	231	
36	\$	85	U	134	â	183	Ã	232	
37	%	86	V	135	ç	184	Ö	233	
38	&	87	W	136	ê	185	§	234	
39	'	88	X	137	ë	186	?	235	
40	(89	Y	138	è	187	†	236	
41)	90	Z	139	ï	188	‡	237	∅
42	*	91	Ä	140	î	189	©	238	
43	+	92	Ö	141	ì	190	®	239	
44	,	93	Ü	142	Ä	191	™	240	
45	-	94	\	143	Å	192	—	241	
46	.	95	˘	144	É	193	...	242	
47	/	96	˘	145	æ	194	‰	243	
48	0	97	a	146	Æ	195	•	244	
49	1	98	b	147	ô	196	—	245	
50	2	99	c	148	ö	197	—	246	
51	3	100	d	149	ò	198	°	247	
52	4	101	e	150	û	199	Á	248	°
53	5	102	f	151	ù	200	Â	249	
54	6	103	g	152	ÿ	201	È	250	
55	7	104	h	153	Ö	202	Ê	251	¹
56	8	105	i	154	Ü	203	Ë	252	³
57	9	106	j	155	ø	204	Ì	253	²
58	:	107	k	156	£	205	Í	254	
59	:	108	l	157	Ø	206	Î	255	
60	<	109	m	158	~	207	Ï		
61	=	110	n	159	—	208	Ò		
62	>	111	o	160	á	209	Ó		
63	?	112	p	161	í	210	Ô		
64	@	113	q	162	ó	211			
65	A	114	r	163	ú	212			
66	B	115	s	164	ñ	213	Ù		
67	C	116	t	165	Ñ	214	Ú		
68	D	117	u	166		215	Û		
69	E	118	v	167		216	ÿ		
70	F	119	w	168		217			
71	G	120	x	169	'	218			
72	H	121	y	170	"	219			
73	I	122	z	171	<	220			
74	J	123	ä	172	>	221			
75	K	124	ö	173		222			
76	L	125	ü	174	«	223	μ		
77	M	126	ß	175	»	224	\		
78	N	127	°	176	ã	225	ß		
79	O	128	Ç	177	ö	226			
80	P	129	ù	178	¥	227			

GEM English

Dec.	Dec.	Dec.	Dec.	Dec.					
32		81	Q	130	é	179	¢	228	€
33	!	82	R	131	â	180	œ	229	
34	'	83	S	132	à	181	Œ	230	μ
35	#	84	T	133	à	182	À	231	
36	\$	85	U	134	â	183	Ã	232	
37	%	86	V	135	ç	184	Ö	233	
38	&	87	W	136	ê	185	§	234	
39	'	88	X	137	ë	186	?	235	
40	(89	Y	138	è	187	†	236	
41)	90	Z	139	ï	188	¶	237	∅
42	*	91	Ä	140	î	189	©	238	
43	+	92	-	141	ì	190	®	239	
44	,	93	Ü	142	Ä	191	™	240	
45	-	94	¼	143	Å	192	—	241	
46	.	95	.	144	É	193	...	242	
47	/	96	`	145	æ	194	‰	243	
48	0	97	a	146	Æ	195	•	244	
49	1	98	b	147	ô	196	—	245	
50	2	99	c	148	ö	197	—	246	
51	3	100	d	149	ò	198	°	247	
52	4	101	e	150	û	199	Á	248	°
53	5	102	f	151	ù	200	Â	249	
54	6	103	g	152	ÿ	201	È	250	
55	7	104	h	153	Ö	202	Ê	251	
56	8	105	i	154	Ü	203	Ë	252	
57	9	106	j	155	ø	204	Ì	253	
58	:	107	k	156	£	205	Í	254	
59	:	108	l	157	∅	206	Î	255	
60	<	109	m	158	~	207	Ï		
61	=	110	n	159	—	208	Ò		
62	>	111	o	160	á	209	Ó		
63	?	112	p	161	í	210	Ô		
64	£	113	q	162	ó	211			
65	A	114	r	163	ú	212			
66	B	115	s	164	ñ	213	Ù		
67	C	116	t	165	Ñ	214	Ú		
68	D	117	u	166	¼	215	Û		
69	E	118	v	167	½	216	ÿ		
70	F	119	w	168	¾	217			
71	G	120	x	169	'	218			
72	H	121	y	170	"	219			
73	I	122	z	171	<	220			
74	J	123	ä	172	>	221			
75	K	124	ö	173		222			
76	L	125	ü	174	«	223	μ		
77	M	126	¾	175	»	224	\		
78	N	127		176	ã	225	ß		
79	O	128	Ç	177	ö	226			
80	P	129	ü	178	¥	227			

GEM French

Dec.	Dec.	Dec.	Dec.	Dec.					
32		81	Q	130	é	179	¢	228	€
33	!	82	R	131	â	180	œ	229	
34	'	83	S	132	à	181	Œ	230	μ
35	#	84	T	133	à	182	À	231	
36	\$	85	U	134	â	183	Ã	232	
37	%	86	V	135	ç	184	Ö	233	
38	&	87	W	136	ê	185	§	234	
39	'	88	X	137	ë	186	?	235	
40	(89	Y	138	è	187	†	236	
41)	90	Z	139	ï	188	‡	237	∅
42	*	91	ô	140	î	189	©	238	
43	+	92	ç	141	ì	190	®	239	
44	,	93	Û	142	Ä	191	™	240	
45	-	94	¼	143	Å	192	—	241	
46	.	95	½	144	É	193	...	242	
47	/	96	¾	145	æ	194	‰	243	
48	0	97	a	146	Æ	195	•	244	
49	1	98	b	147	ô	196	—	245	
50	2	99	c	148	ö	197	—	246	
51	3	100	d	149	ò	198	°	247	
52	4	101	e	150	û	199	Á	248	°
53	5	102	f	151	ù	200	Â	249	
54	6	103	g	152	ÿ	201	È	250	
55	7	104	h	153	Ö	202	Ê	251	
56	8	105	i	154	Ü	203	Ë	252	
57	9	106	j	155	ø	204	Ì	253	
58	:	107	k	156	£	205	Í	254	
59	:	108	l	157	∅	206	Î	255	
60	<	109	m	158	~	207	Ï		
61	=	110	n	159	—	208	Ò		
62	>	111	o	160	á	209	Ó		
63	?	112	p	161	í	210	Ô		
64	à	113	q	162	ó	211			
65	A	114	r	163	ú	212			
66	B	115	s	164	ñ	213	Ù		
67	C	116	t	165	Ñ	214	Ú		
68	D	117	u	166	¼	215	Û		
69	E	118	v	167	½	216	ÿ		
70	F	119	w	168	¾	217			
71	G	120	x	169	'	218			
72	H	121	y	170	"	219			
73	I	122	z	171	<	220			
74	J	123	é	172	>	221			
75	K	124	ñ	173		222			
76	L	125	è	174	«	223	μ		
77	M	126	ß	175	»	224	\		
78	N	127	°	176	ã	225	ß		
79	O	128	Ç	177	ö	226			
80	P	129	ü	178	¥	227			

GEM Swedish

Dec.	Dec.	Dec.	Dec.	Dec.					
32		81	Q	130	é	179	¢	228	€
33	!	82	R	131	â	180	œ	229	
34	'	83	S	132	à	181	Œ	230	μ
35	#	84	T	133	à	182	À	231	
36	\$	85	U	134	â	183	Ã	232	
37	%	86	V	135	ç	184	Ö	233	
38	&	87	W	136	ê	185	§	234	
39	'	88	X	137	ë	186	?	235	
40	(89	Y	138	è	187	†	236	
41)	90	Z	139	ï	188	‡	237	∅
42	*	91	Ä	140	î	189	©	238	
43	+	92	Ö	141	ì	190	®	239	
44	,	93	À	142	Ä	191	™	240	
45	-	94	Ü	143	Å	192	—	241	
46	.	95	_	144	É	193	...	242	
47	/	96	é	145	æ	194	‰	243	
48	0	97	a	146	Æ	195	•	244	
49	1	98	b	147	ô	196	—	245	
50	2	99	c	148	ö	197	—	246	
51	3	100	d	149	ò	198	°	247	
52	4	101	e	150	û	199	Á	248	°
53	5	102	f	151	ù	200	Â	249	
54	6	103	g	152	ÿ	201	È	250	
55	7	104	h	153	Ö	202	Ë	251	
56	8	105	i	154	Ü	203	Ë	252	
57	9	106	j	155	ø	204	Ì	253	
58	:	107	k	156	£	205	Í	254	
59	:	108	l	157	∅	206	Î	255	
60	<	109	m	158	~	207	Ï		
61	=	110	n	159	—	208	Ò		
62	>	111	o	160	á	209	Ó		
63	?	112	p	161	í	210	Ô		
64	@	113	q	162	ó	211			
65	A	114	r	163	ú	212			
66	B	115	s	164	ñ	213	Ù		
67	C	116	t	165	Ñ	214	Ú		
68	D	117	u	166	¼	215	Û		
69	E	118	v	167	½	216	ÿ		
70	F	119	w	168	¾	217			
71	G	120	x	169	'	218			
72	H	121	y	170	"	219			
73	I	122	z	171	<	220			
74	J	123	ä	172	>	221			
75	K	124	ö	173		222			
76	L	125	å	174	«	223	μ		
77	M	126	ü	175	»	224	\		
78	N	127	°	176	ã	225	ß		
79	O	128	Ç	177	õ	226			
80	P	129	ü	178	¥	227			

GEM Danish

Dec.	Dec.	Dec.	Dec.	Dec.					
32		81	Q	130	é	179	¢	228	€
33	!	82	R	131	â	180	œ	229	
34	'	83	S	132	à	181	Œ	230	μ
35	#	84	T	133	à	182	À	231	
36	\$	85	U	134	â	183	Ã	232	
37	%	86	V	135	ç	184	Ö	233	
38	&	87	W	136	ê	185	§	234	
39	'	88	X	137	ë	186	?	235	
40	(89	Y	138	è	187	†	236	
41)	90	Z	139	ï	188	‡	237	∅
42	*	91	Æ	140	î	189	©	238	
43	*	92	Ø	141	ì	190	®	239	
44	,	93	Å	142	Ä	191	™	240	
45	—	94	Ö	143	Å	192	—	241	
46	.	95	—	144	É	193	...	242	
47	/	96	—	145	æ	194	‰	243	
48	0	97	a	146	Æ	195	•	244	
49	1	98	b	147	ô	196	—	245	
50	2	99	c	148	ö	197	—	246	
51	3	100	d	149	ò	198	°	247	
52	4	101	e	150	û	199	Á	248	°
53	5	102	f	151	ù	200	Â	249	
54	6	103	g	152	ÿ	201	È	250	
55	7	104	h	153	Ö	202	Ë	251	
56	8	105	i	154	Ü	203	Ë	252	
57	9	106	j	155	ø	204	Ì	253	
58	:	107	k	156	£	205	Í	254	
59	:	108	l	157	Ø	206	Î	255	
60	<	109	m	158	~	207	Ï		
61	=	110	n	159	—	208	Ò		
62	>	111	o	160	á	209	Ó		
63	?	112	p	161	í	210	Ô		
64	ä	113	q	162	ó	211			
65	A	114	r	163	ú	212			
66	B	115	s	164	ñ	213	Ù		
67	C	116	t	165	Ñ	214	Ú		
68	D	117	u	166	¼	215	Û		
69	E	118	v	167	½	216	ÿ		
70	F	119	w	168	¾	217			
71	G	120	x	169	'	218			
72	H	121	y	170	"	219			
73	I	122	z	171	<	220			
74	J	123	æ	172	>	221			
75	K	124	ø	173		222			
76	L	125	å	174	«	223	μ		
77	M	126	Û	175	»	224	\		
78	N	127	°	176	ã	225			
79	O	128	Ç	177	ö	226	ß		
80	P	129	ü	178	¥	227			

FONT EXAMPLES

Bitmap fonts (not proportional)

Font 01 (8 x 11) ratio 3:3
Font 02 (12 x 17) ratio 3:3
Font 03 (18 x 26) ratio 2:2
Font 04 (40 x 56) ratio 1:1
Font 05 (18 x 32 with descender) ratio 2:2
Font 07 (12 x 22 with descender) ratio 2:2

Bitmap fonts (proportional)

Font 21 (10 proportional) ratio 3:3
Font 22 (18 proportional) ratio 2:2
Font 23 (26 proportional) ratio 2:2
Font 24 (56 proportional) ratio 1:1
Font 28 (40 proportional) ratio 1:1
Font 29 (8 proportional) ratio 5:5

INDEX

A

ANSI, character set	65
Auto status.....	61

B

Bar code	
Mask set.....	14
Rotation.....	6
Bitmap fonts, font examples	75

C

Character sets	
ANSI.....	65
Codepage 437	66
Codepage 850	67
Codepage 852	68
Codepage 857	69
GEM Danish.....	74
GEM English	71
GEM French.....	72
GEM German.....	70
GEM Swedish	73
General information	63
CODABLOCK F, mask set	19
Codepage 437, character set	66
Codepage 850, character set	67
Codepage 852, character set	68
Codepage 857, character set	69
Codepage selection, parameter set	41
Columns	
Number, parameter set.....	36
Width, parameter set.....	36
Configuration	
Readout	60
Save permanent.....	60
Connector assignment RS485/RS422, serial data transmission	3
Contrast, parameter set.....	37
Counter (extended), variables	31
Counter, variables	30
Currency, variable	32
Cutter (option)	
Offset, parameter set	45, 55
Operating mode	55

D

Data format	
Explanation	8
General information	7
Data memory, parameter set.....	43
DataMatrix, mask set.....	18
Date/time	
Date.....	57
Summer/wintertime	58
Summertime begin.....	59
Summertime end.....	59
Time	57
time shifting.....	59

Datumpoint, setting.....	6
DHCP support, parameter set	53
Dispenser	
Photocell (status), parameter set.....	39, 56
Photocell (value), parameter set.....	56
Dispenser (option)	
Dispenser offset.....	45
Offset.....	56
Operating mode	56
E	
Enquire value (label photocell), parameter set.....	38
Error (readout)	
ID, parameter set	47
Text, parameter set.....	47
Error (reset), parameter set.....	47
ETB, parameter set	42
Example	
Graphic, PCX format.....	28
Mask set.....	25
Text set	25
External print parameters, parameter set.....	41
F	
Feed, parameter set	50
Field attributes/properties, definition	9
Field handling, parameter set.....	40
Field names, definition.....	10
Flip label, parameter set.....	37
Font examples	
Bitmap fonts (not proportional)	75
Bitmap fonts (proportional)	75
G	
Gap length in 1/100 mm, parameter set.....	35
Gateway address (network), parameter set	53
GEM Danish, character set	74
GEM English, character set.....	71
GEM French, character set	72
GEM German, character set.....	70
GEM Swedish, character set.....	73
Graphic	
General format.....	26
Internal, mask set.....	23
PCX format, example.....	28
PCX format, general information	27
Rotation.....	6
GS1 DataBar (RSS), mask set.....	20
I	
Interface	
All interface parameters	42
Date memory	43
Interface protocol	42
Port transmission	43
SOH/ETB	42
Unknown interrogative set, reaction	43
Interrogative sets (unknown), reaction	43
IP address (network), parameter set	52
ITF 14, mask set.....	15

L

Label	
Alignment, parameter set.....	36
Error length, parameter set.....	35
Length in 1/100 mm, parameter set.....	35
Measure, parameter set.....	34
Type, parameter set.....	34
Label parameter	
Column width.....	36
Flip label.....	37
Flip/rotate label.....	37
Gap length in 1/100 mm.....	35
Label alignment.....	36
Label error length.....	35
Label length in 1/100 mm.....	35
Label photocell.....	34
Label type.....	34
Label width in 1/100 mm.....	35
Measure label.....	34
Number of columns.....	36
Rotate label.....	37
Scan position.....	37
Synchronisation.....	36
Label photocell	
Enquire value (label photocell).....	38
Level, maximal.....	38
Level, minimal.....	38
Parameter set.....	34
Switching threshold.....	38
Label width in 1/100 mm, parameter set.....	35
Language, parameter set.....	40
Line, mask set.....	22
Lines (number), parameter set.....	47
Link field, variables.....	29

M

MAC address (network), parameter set.....	54
Mask set	
Bar code.....	14
CODABLOCK F.....	19
DataMatrix.....	18
Example.....	25
Graphic internal.....	23
GS1 DataBar (RSS).....	20
ITF 14.....	15
Line.....	22
MAXICODE.....	17
PDF417.....	16
QR Code.....	21
Rectangle.....	22
Text.....	13
MAXICODE, mask set.....	17
Mileage	
Printer, parameter set.....	46
Printhead, parameter set.....	46

N

Network (option)	
DHCP support.....	53
Gateway address.....	53
IP address.....	52
MAC address.....	54
Netmask.....	52
Printer name.....	54
Reset network device.....	54
Transmission mode.....	53

O

Offset values	
Cutter (option) offset.....	45
Dispenser offset.....	45
Tear off (offset 4).....	44
X displacement (offset 3).....	44
Zero point displacement (offset 2).....	44
Operating mode	
Cutter, parameter set.....	55
Dispenser, parameter set.....	56

P

Parallel data transmission	
Connection.....	5
General information.....	4
Parameter set	
Date/time.....	57
Test print.....	50
Parameter sets	
Cancel print orders.....	50
Cutter (option).....	55
Dispenser (option).....	56
Dispensing photocell.....	39, 56
Error ID, readout.....	47
Error text, readout.....	47
Feed.....	50
Interface.....	42
Label parameter.....	34
Label photocell.....	38
Network (option).....	52
Offset values.....	44
Printer settings.....	40
Printing.....	47
Quantity (print order).....	48
Remote console.....	51
Reset error.....	47
Service functions.....	46
Start printing.....	49
Start/stop command.....	47
Status print.....	50
PDF417, mask set.....	16
Photocell (label)	
Level (maximal), parameter set.....	38
Level (minimal), parameter set.....	38
Port transmission, parameter set.....	43
Print	
Speed, parameter set.....	40
Start, parameter set.....	49

Print orders (cancel), parameter set.....	50
Printer name (network), parameter set.....	54
Printer settings	
Codepage selection	41
Contrast	37
External print parameters.....	41
Field handling.....	40
Print speed	40
Printer language.....	40
Transfer ribbon control.....	40
Printhead temperature, parameter set	46
Printing, lines	47
Q	
QR Code, mask set	21
Quantity (print order), parameter set	48
R	
Readout, configuration	60
Rectangle, mask set.....	22
Remote console, parameter set	51
Reset network device (network), parameter set.....	54
Rotate label, parameter set.....	37
Rotation	
Bar code.....	6
Graphic	6
Text	6
RS232	
Assignment, cable.....	2
Hardware handshake.....	2
S	
Save permanent, configuration	60
Scan position, parameter set.....	37
Serial data transmission	
Connection RS232.....	2
Connector assignment RS485/RS422.....	3
Connector assignment, DSUB socket	1
Xon/Xoff protocol	1
Service functions	
Mileage, printer	46
Mileage, printhead	46
Printhead temperature	46
SOH, parameter set.....	42
Start/stop command, parameter set.....	47
Status	
Enquiry, data format.....	60
Print, parameter set	50
Return information, data format.....	60
Summer/wintertime (parameter sets)	
Automatic adjustment.....	58
Summertime begin.....	59
Summertime end.....	59
Time shifting.....	59
Switching threshold, parameter set	38
Synchronisation, parameter set.....	36

T

Tear off (offset 4), parameter set.....	44
Test print, parameter set	50
Text	
Mask set.....	13
Rotation.....	6
Set, example.....	25
Set, general information.....	24
Time, parameter set	57
Transfer ribbon control, parameter setl	40
Transmission mode (network), parameter set.....	53

V

Variables	
Counter	30
Currency variable.....	32
Extended counter.....	31
Link field.....	29
Text structure	29

X

X displacement (offset 3), parameter set	44
--	----

Z

Zero point, displacement (offset 2), parameter set	44
--	----



Carl Valentin GmbH
Neckarstraße 78 – 86 u. 94 . 78056 Villingen-Schwenningen
Phone +49 (0)7720 9712-0 . Fax +49 (0)7720 9712-9901
info@carl-valentin.de . www.carl-valentin.de